



Thermo Scientific Barnstead Smart2Pure Ultrapure water system

Operating Instructions

50148311 Revision B June 2016

© 2016 Thermo Fisher Scientific Inc. All rights reserved.

Thermo Fisher Scientific Inc. provides this document to its customers with a product purchase to use in the product operation. This document is copyright protected and any reproduction of the whole or any part of this document is strictly prohibited, except with the written authorization of Thermo Fisher Scientific Inc.

The contents of this document are subject to change without notice. All technical information in this document is for reference purposes only. System configurations and specifications in this document supersede all previous information received by the purchaser.

This document is not part of any sales contract between Thermo Fisher Scientific Inc. and a purchaser. This document shall in no way govern or modify any Terms and Conditions of Sale, which Terms and Conditions of Sale shall govern all conflicting information between the two documents.

Release history:

For Research Use Only. Not for use in diagnostic procedures.

Preface

© 2016 Thermo Fisher Scientific Inc. All rights reserved.

These operating instructions are protected by copyright. Rights resulting thereof, particularly reprint, photomechanical or digital postprocessing or reproduction, even in part, are only allowed with the written consent of Thermo Electron LED GmbH. This regulation does not apply to reproductions for in-plant use. The contents of this operating instructions manual may change at any time and without any prior notice. In case of conflicting translations into foreign languages the German-language version of these operating instructions shall be binding.

Please read through the information given in these operating instructions on installing and operating the system before you begin installation and use of your water purification system. This is of particular importance, as we, the manufacturer, do not assume any liability for damage due to incorrect operation or use of the system other than the intended use.

Thermo Fisher Scientific Inc. provides this document to its customers with a product purchase to use in the product operation. This document is copyright protected. Any reproduction of the whole or any part of this document is strictly prohibited, except with the written authorization of Thermo Fisher Scientific Inc. The contents of this document are subject to change without notice. All technical information in this document is for reference purposes only. System configurations and specifications in this document supersede all previous information received by the purchaser.

Thermo Fisher Scientific Inc. makes no representations that this document is complete, accurate or error-free and assumes no responsibility and will not be liable for any errors, omissions, damage or loss that might result from any use of this document, even if the information in the document is followed properly.

This document is not part of any sales contract between Thermo Fisher Scientific Inc. and a purchaser. This document shall in no way govern or modify any Terms and Conditions of Sale, which Terms and Conditions of Sale shall govern all conflicting information between the two documents.

Legal Information



Specifications, terms and pricing are subject to change. Not all products are available in all countries. Please consult your local sales representative for details.

Warranty

Thermo Electron LED GmbH warrants the operational safety and functions of the Thermo Scientific Barnstead Ultrapure Water Systems only under the condition that:

- The system is installed and operated as per the operation manual. Do not use this product for anything other than its intended use.
- the system is not modified,
- only original spare parts and accessories that have been approved by Thermo Electron LED GmbH are used (third-party spares without Thermo Electron LED GmbH approval void the limited warranty),
- inspections and maintenance are performed at the specified intervals,
- an installation verification test is performed on commissioning the system for the first time and repeated after each preventative maintenance and repair activity. The warranty is valid from the date of delivery of the system to the customer.
- The above mentioned warranty conditions are subject to the general terms and conditions of sale, in effect at the time of purchase, which apply as well.

Explanatory notes on the operating instructions



EU Mark of Conformity



CSA - admission



Indicates a situation which, if not avoided, could result in damage to equipment or property.



Indicates a hazardous situation which, if not avoided, could result in death or serious injuries.



Indicates a hazardous situation which, if not avoided, will result in death or serious injuries.



Is used for applicational hints and useful information.



Risk of electric shock. Electrical work on the system is only to be carried out by qualified personnel.



Protective conductor connection

Connect the power supply to an electrical socket with a protective connection.



Indicates a situation in which protective gloves or clothing must be worn.



Indicates a situation in which protective goggles must be worn.



Indicates a situation in which breathing protection must be used.

This information is valid for the system that is received. For quick and correct service, please include the following information on all inquiries and replacement parts orders which relate to your system:

- the serial number (located on the right side of the system on the nameplate)
- the catalog number

Standards and directives

The Thermo Scientific Barnstead Ultrapure Water Systems complies with the following standards and directives:

- Low Voltage Directive 2014/35/EC
- EMC Directive 2014/30/EU
- ASTM D1193-6
- RoHs 2011/65/EU

Additionally, the ultrapure water system is in compliance with many other international standards, regulations and directives not listed here. Should you have any questions regarding compliance with national standards, regulations and directives applicable for your country, please contact your Thermo Fisher Scientific sales organization.

Contents

	Preface	i
	Legal Information	ii
	Warranty	ii
	Explanatory notes on the operating instructions	ii
	Standards and directives	iv
Chapter 1	Transport and packaging	1
	Examination on receipt	2
	Complaints	2
	Packaging for return shipment	2
Chapter 2	Safety Precautions	5
Chapter 3	Extend of delivery	9
	Extend of delivery Smart2Pure 3/6	10
	Extend of Delivery Smart2Pure 12	11
	Available Smart2Pure 3/6 systems	12
	Available Smart2Pure 12 systems	13
	Available storage tanks for Smart2Pure 12 systems	13
Chapter 4	Intended Use of the device	15
	Intended Use	15
	Unintended use	15
Chapter 5	Technical Specifications	17
Chapter 6	The Installation area	23
Chapter 7	Installation	25
	Connections of the Smart2Pure 3/6 system	26
	Connections of the Smart2Pure 12 system	28
	Connections of the pure water tank Smart2Pure 12	30
	Bring your Smart2Pure system into operation	31
	Connecting an external tank to the Smart2Pure 12 system	34
	Illustration of drain	35

	Attaching the wall holder for 30 or 60L pure water tank	36
	Attaching wall holder for 30L pure water tank.	37
	Attaching wall holder for 60L pure water tank.	40
	Wall mounting	42
	Mounting the power pack (voltage supply)	43
	Mounting the ball valve to the Smart2Pure system	45
Chapter 8	Flow chart	47
Chapter 9	How the Smart2Pure system functions	49
Chapter 10	Initial start up	51
	Putting the system into operation	52
	Dispensing water from the dispensing valve.	54
	Venting the 0.2 µm final filter	54
Chapter 11	Operating Elements	55
Chapter 12	System control	57
	Menu	58
	Mono/dual measurement mode.	58
	Setting the limiting value for conductivity.	59
	Setting the limiting value for temperature	60
	Error message and acoustic error signal	61
	Communication	61
	Potential-free contact.	62
Chapter 13	Maintenance	63
	Maintenance Intervals	64
	Replacing the ultrapure cartridge.	65
	Replacing the RO/pretreatment.	66
	Cleaning	68
	Changing the ultrafilter.	71
	UV-reactor assembly	73
	Replacing the UV lamp	74
	Replacing the 0.2 µm final filter	76
	Autoclaving the 0.2 µm final filter.	76
Chapter 14	Waste disposal	77
Chapter 15	Trouble shooting.	79
Chapter 16	Replacement parts	81
	Replacement parts Smart 2Pure 3/6.	82
	Replacement parts Smart2Pure 12.	84
	Replacement parts pure water tank for Smart2Pure 12	86

Chapter 17 Consumables	87
Accessories.....	87
Chapter 18 Terminal assignment	89
Chapter 19 Maintenance record	91
Chapter 20 Contact information Thermo Fisher Scientific	93
Index	95

Transport and packaging

Content

- “Examination on receipt” on page 5
- “Complaints” on page 5
- “Packaging for return shipment” on page 5



Do not pull the plastic foil over your head. Risk of suffocation.
Use the plastic foil only for packaging.

Ultrapure water systems are carefully inspected and packed prior to shipping, but damage could still possibly occur during transport. Lifting and carrying the Thermo Scientific Barnstead Smart2Pure ultrapure water system, e.g. to the installation location, should be carried out by two people.

Examination on receipt

Check the completeness of the goods received against the packing list.

NOTICE

Does the packaging show signs of damage? Inspect the system for damage.

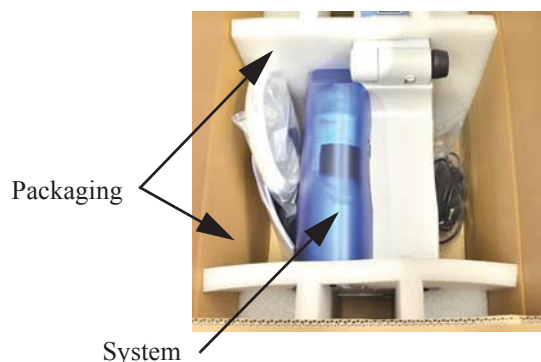

Complaints

Should damage have occurred to the goods during transport:

- Immediately contact your delivery transport agency.
- Save the complete packaging, including the cardboard box, for a possible inspection of them and/or return shipment of the system.

Packaging for return shipment

If possible, use the original box and packaging material.

When these are no longer available, then:

- Protect the system from shock by packing it in bubble wrap and/or packaging foam and a strong cardboard box.

NOTICE

The time limit for claims is 6 days from the time of receipt of the goods. The right to claim for damages ceases when this time has elapsed.

NOTICE

- Only a trained person should take the system out of operation.
- Prior to send back a operated device, empty the water and dry the system and take out the cartridges.
- pack the ultrapure cartridges into a bubble wrap and/or packaging foam and take it with in into the package of the Smart2Pure ultrapure water system.

Safety Precautions

NOTICE

Observe these safety precautions for your own safety!

CAUTION

The Thermo Scientific Barnstead Ultrapure Water Systems are modern water purification systems intended solely for the treatment of potable water. The water it produces is not fit for drinking.

DANGER

Work may only be performed on the system electronics when the system has been switched off and when ESD protection is in place. Only specially trained personnel may work on the system's electronics.



- Do not install or operate the system until you have carefully read through these operating instructions and the notes and notices contained therein.
- Lifting and carrying the ultrapure water system, e.g. to the installation location, should be carried out by two people. To do this, lift the system in tandem at the two corner points beneath the bottom plate.
- The CE mark is nullified if you make any structural changes to the system or install products from other manufacturers in/on the system.
- Protect the system from frost. The temperature at the installation area must be between +2 °C and +40 °C.
- Always observe the applicable, pertinent codes and regulations valid at the installation location of the system and follow all applicable accident prevention regulations.
- The feedwater pressure must be at least 0.1 bar and at max. 6 bar or 1.45 to 87 PSI. When the feedwater pressure is higher, install an external pressure reducer.
- A low pressure check valve is recommended to prevent back flow of feedwater from water system.
- A grounded 100-240V, 50/60Hz electrical outlet must be available (see '[Electrical connections](#)' on [page 21](#)).
- Access to the power supply cord and plug may never be restricted or obstructed.
- Unplug the system from the power outlet for all maintenance work on the system.

- An atmospherically vented floor drain with a nominal diameter of at least 63 mm (2.48 inch) (DN50 tube) must be present at the installation location. If no drain is provided it is recommended that a water detector be installed for safety reasons (for European specifications only). Failure to provide this will release the manufacturer from liability for any water-induced damage that may result.
- Proceed as follows if the system is not to be operated for an extended period, e.g., over extended weekend, or during a vacation period:
 - Switch the system off (unplug the mains plug).
 - Close the feedwater inlet (close the feedwater tap).The pump would be damaged if the system were to run without any supply of feedwater. The manufacturer will not accept any liability should this occur.
- The system must be disinfected or rinsed after an extended down time. The cleaning procedure is described under '[Cleaning](#)' on [page 68](#).
- The surface or wall on which the system is to be installed or mounted must have an adequate load-carrying capacity (check the capacity and stability of the wall). The dry weight of the system is given under '[Dimensions and weight Smart2Pure 3/6](#)' on [page 18](#) and '[Dimensions and weight of Smart2Pure12](#)' on [page 19](#). When the internal tank is filled, the system has a weight during operation of approx. 32 kg / 70.55 lbs.
- The surface on which the system is installed must be level and stable not to exceed a maximum of 2% deviation from evenness is recommended.
- When installing the water purification system, always ensure that there is adequate space all around the system (see '[Accessibility to Smart2Pure systems and pure water tank](#)' on [page 21](#)) to ensure that ease of use or easy replacement of materials (e.g., filter change, connection) is possible at all times.
- Visually inspect the system at regular intervals. Clean up any water or spills found around the system immediately.

WARNING

Never look directly into a switched-on UV-lamp, as UV-light endangers eyesight!

CAUTION

To avoid the risk of pinching, crushing, cutting or electrical shock, never perform maintenance on the system without its protective housing, or while it is in operation. Maintenance work on the system may only be performed by trained, authorized specialists.



- Wear safety gloves when working with cleaning solutions.
- If your skin should come into contact with a chlorine product, rinse it immediately with ample, fresh water.
- The system, or system components, may heat up as a result of a defect. It is recommended to always wear appropriate safety gloves to prevent skin damage or burns.
- Wear safety gloves when changing the UV-lamp, in order to prevent that your skin comes in contact with the UV-lamp glass.



- Wear safety glasses when working with cleaning solutions.
- If your eyes come into contact with a chlorine product, rinse them immediately with ample, fresh water and contact a physician at once.



- Check the UV-lamp before initial start.
 - If the UV-lamp is broken
 - wear a breathing protector, filter category FFP3 and replace the UV-lamp. For disposal the UV-lamp refer to 'Waste disposal' on [page 77](#).
 - ventilate the room well.

NOTICE

The Hg content in the UV-lamp is so low so that no damage to the environment can arise.

- To avoid tripping, ensure that the tubings do not lay over the floor.
- Apply the general rules of hygiene for laboratories when working with the system.
- Do not use any oxidative cleaning agents for cleaning the system. These can damage the system.
- Proceed as follows when the system has a defect:
 - Switch the system off and unplug the system from power outlet.
 - Shut off the feedwater supply.
 - Contact your local service organization.

Extend of delivery

Contents

- "Extend of delivery Smart2Pure 3/6" on page 10
- "Extend of Delivery Smart2Pure 12" on page 11
- "Available Smart2Pure 3/6 systems" on page 12
- "Available storage tanks for Smart2Pure 12 systems" on page 13

Extend of delivery Smart2Pure 3/6

The following items are included with the Smart2Pure 3/6 pure water system:

1x Smart2Pure 3/6 ultrapure water system:	Item No.: 5012xxxx
1 x Ultrapure cartridge	Item No.: 09.1020
1x RO/pretreatment cartridge for a 3 l/h system	Item No.: 09.2003
for a 6 l/h system	Item No.: 09.2006
including 1 x assembly kit	Item No.: 50129959
consisting of:	
1 x Final final filter (sterile filter 0.2 µm)	Item No.: 09.1003
1 x Sterile vent air filter	Item No.: 22.0091
1 x Feedwater connecting kit	Item No.: 25.0071
1 x Connectiong tube AD 1/4" 6 m/8.22 inch	Item No.: 18.0137
1 x Ball valve 1/4"	Item No.: 15.0112
1 x cleaning adapter	Item No.: 50133431
1 x Table top power pack	Item No.: 50149597
1 x Universal adapter	Item No.: 21.1006
1 x Universal holder	Item No.: 21.1007
1 x Rubber connector to nema plug connector	Item No.: 50132200
1x Rubber connector to british ST plug connector	Item No.: 50132203
1x Rubber connector to euro plug connector	Item No.: 50132215
1 x Plug angle connector 1/4"	Item No.: 14.0361
1 x T-connector 1/4"	Item No.: 14.0362
2 x Nylon plugs S6	Item No.: 21.002
2 x Countersunk wood screw 4 x 35	Item No.: 21.0069

Extend of Delivery Smart2Pure 12

The following items are included with the Smart2Pure 12 pure water system:

1 x Smart2Pure 12 ultrapure water system:	Item No.: 5012xxxx
1 x Ultrapure water tank	30L storage tank or 60L storage tank
	Item No.: 06.5030
	Item No.: 06.5060
1 x Ultrapure cartridge	Item No.: 09.1020
1 x RO/pretreatment cartridge	Item No.: 09.2012
including 1 x assembly kit	Item No.: 50129959
consisting of:	
1 x Final final filter (sterile filter 0.2 µm)	Item No.: 09.1003
1 x Feedwater connecting kit	Item No.: 25.0071
1 x Connectiong tube outer diameter 1/4" 6 m/8.22 inch	Item No.: 18.0137
1 x Ball valve 1/4"	Item No.: 15.0112
1 x Cleaning adapter	Item No.: 50133431
1 x Table top power pack	Item No.: 50149597
1 x Universal adapter	Item No.: 21.1006
1 x Universal holder	Item No.: 21.1007
1 x Rubber connector to nema plug connector	Item No.: 50132200
1x Rubber connector to british ST plug connector	Item No.: 50132203
1x Rubber connector to euro plug connector	Item No.: 50132215
1 x Plug angle connector 1/4"	Item No.: 14.0361
1 x T-connector 1/4"	Item No.: 14.0362
2 x Nylon plugs S6	Item No.: 21.002
2 x Countersunk wood screw 4 x 35	Item No.: 21.0069

Available Smart2Pure 3/6 systems

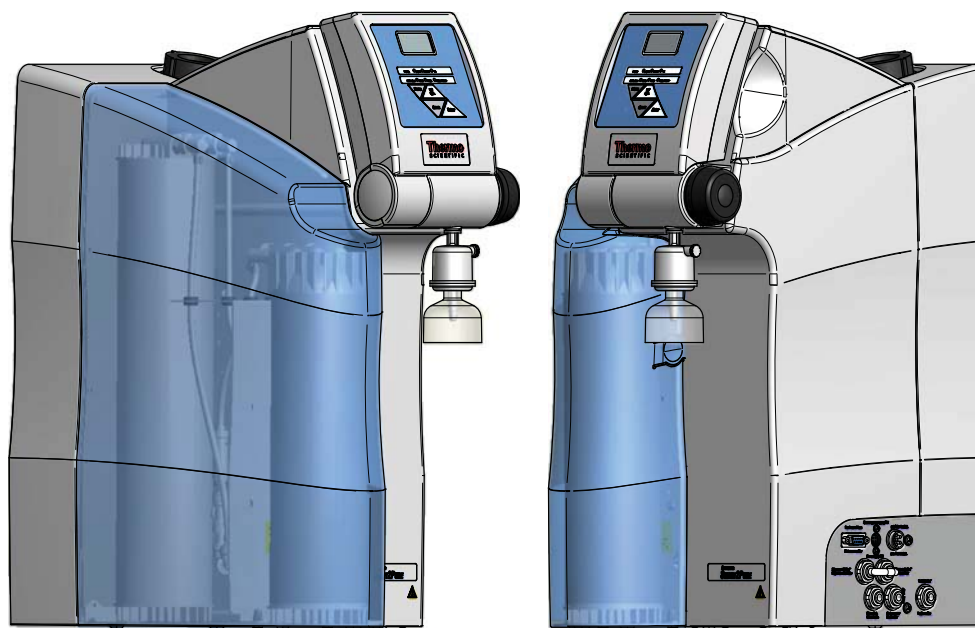

Item No.:	System
50129869	Smart2pure 3 Standard
50129870	Smart2pure 3 UF
50129872	Smart2pure 3 UV
50129688	Smart2pure 3 UV/UF
50129873	Smart2pure 6 Standard
50129874	Smart2pure 6 UF
50129885	Smart2pure 6 UV
50129887	Smart2pure 6 UV/UF

Available Smart2Pure 12 systems

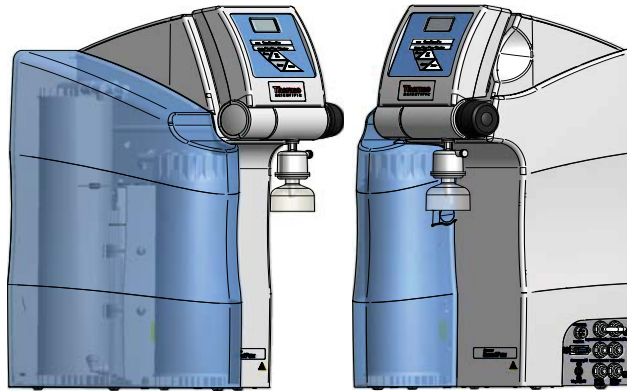

Item No.:	System
50129888	Smart2pure 12 Standard
50129889	Smart2pure 12 UF
50129890	Smart2pure 12 UV
50129845	Smart2pure 12 UV/UF

Available storage tanks for Smart2Pure 12 systems

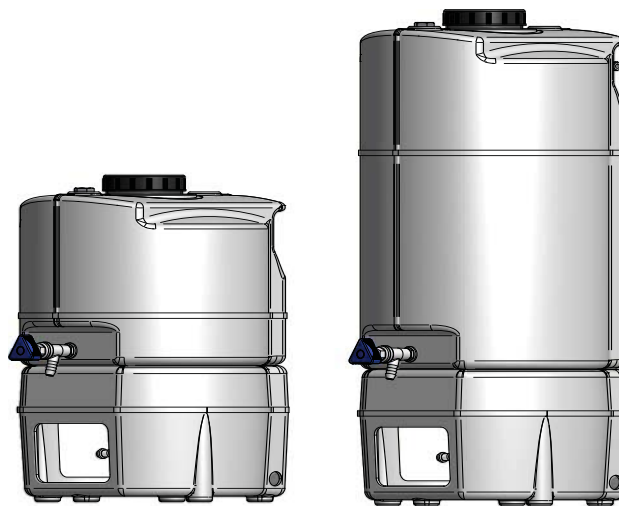

Item No.:	System	Capacity
06.5040	Pure water tank	30 liter
06.5070	Pure water tank	60 liter

Intended Use of the device

Intended Use:

The Thermo Scientific Barnstead Ultrapure Water Systems are laboratory system and is used for treatment of water. The system allows the purification of water into the water categories mentioned in the standards of ASTM 11.01 and ASTM 11.02.

The Thermo Scientific Barnstead Ultrapure Water System are designed to be installed and use in the following application areas:

- Laboratories for cell biological and biotechnological work with the safety levels L1, L2 and L3.
- Medical and microbiological laboratories according to DIN EN 12128.
- Laboratories in the central area of clinics and hospitals.

Unintended use:

The system must not be operated outside of the specifications as described in the operating manual. In particular, the system may not be used for production of drinking water and drugs manufacturing. The system must not be used as a medical device and outside of laboratories.

Technical Specifications

NOTICE

Check at regular intervals the quality of your feedwater.

Feedwater requirements

Source	potable tap water pre-treated with required 09.4000 (sold separately)
Silt density index (SDI)	Bacteria should be < 0.01
Conductivity (reference temperature +25 °C)	1200 µS/cm (0.0008 MΩ·cm)
Free chlorine	max. 0.1 ppm
Manganese content	max. 0.05 ppm
Iron content	max. 0.05 ppm
pH range	4 - 11
Temperature	+2°C - +35°C
Pressure	1 - 6 bar / 14 - 87 PSI (at a pressure > 6 bar / 87 PSI a pressure reducer must be installed upstream of the system.)

Product water quality ASTM Type I (on dispensing valve)

		Standard	UV	UF	UV/UF
Conductivity (reference temperature +25 °C)	µS/cm	0.055	0.055	0.055	0.055
Resistance (reference temperature +25°C)	MΩ·cm	18.2	18.2	18.2	18.2
TOC value	ppb	5-10	1-5	5-10	1-5
RNase	ng/ml	--	--	--	< 0.003
DNase	pg/ul	--	--	--	< 0.4
Bacteria	CFU/ml	< 0.1	< 0.1	< 0.1	< 0.1
Bacterial endotoxins	EU/ml	--	--	< 0.001	< 0.001
Particles	µm/ml	< 0.2	< 0.2	< 0.2	< 0.2
Performance	l/min	1.0	1.0	0.6	0.6

Product water quality ASTM Type II (tank quality)

		Standard	UV	UF	UV/UF
Conductivity (reference temperature +25 °C)	µS/cm	0.067-1.0	0.067-1.0	0.067-1.0	0.067-1.0
Resistance (reference temperature +25°C)	MΩ·cm	15-10	15-10	15-10	15-10
Retention rate for bacteria and particles	%	99	99	99	99
Tank capacity Smart2Pure 3/6	Liter	5	5	5	5
External tank capacity Smart2Pure 12	Liter	up to 60	up to 60	up to 60	up to 60



The pressure hold valve for concentrate is factory adjusted. Changing of this adjustment causes damage to the reverse osmosis membrane in the RO/pretreatment cartridge. Only specially trained personnel may adjust this pressure. The position of the pressure hold valve for concentrate see chapter [Chapter 16, “Replacement parts.”](#)

Permeate and concentrate performance for Smart2Pure			
System		Permeate	Concentrate
All Smart2Pure 3	l/h	3	50
All Smart2Pure 6	l/h	6	55
All Smart2Pure 12	l/h	12	60

Dimensions and weight Smart2Pure 3/6	
Height	545 mm / 21.46 inch
Width	305 mm / 12.01 inch
Depth	400 mm / 15.75 inch
Base area	277 x 372 mm / 10.91 x 14.65 inch
Weight including ultrapure cartridge and RO/pretreatment cartridge and full tank	33 kg / 72.77 lbs

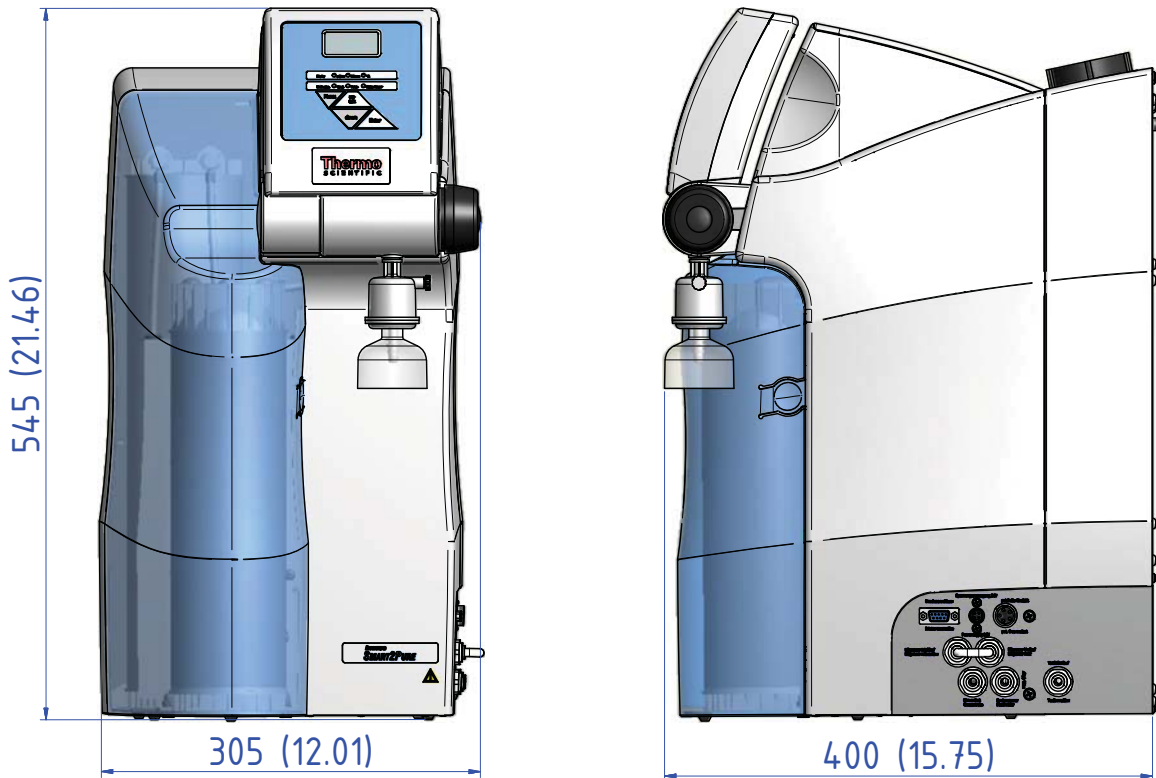

Dimensions and weight of Smart2Pure12

Height	545 mm / 21.46 inch
Width	305 mm / 12.01 inch
Depth	300 mm / 11.81 inch
Base area	277 x 372 mm / 10.91 x 14.65 inch
Weight including ultrapure cartridge and RO/pretreatment cartridge	28 kg / 61.74 lbs

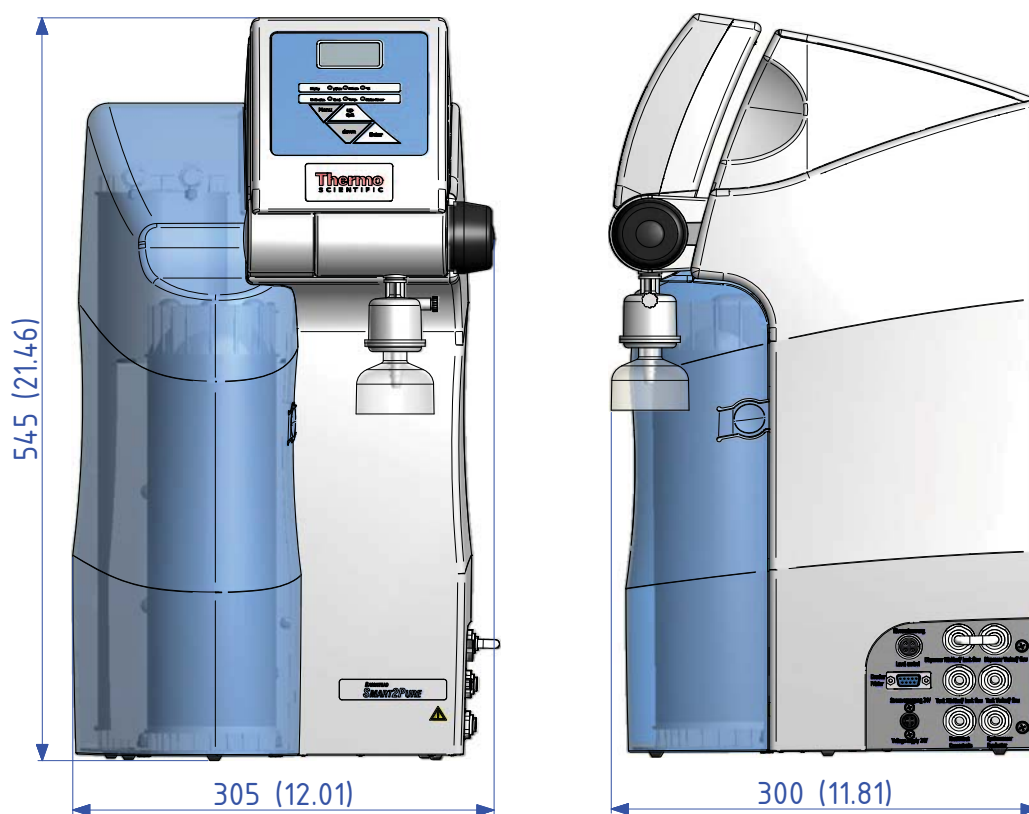

Dimensions and weight 30L and 60L pure water tank		
System	30L pure water tank	60L pure water tank
Height	606 mm / 23.86 inch	920 mm / 36.22 inch
Width	Ø 388 / 15.28 inch	Ø 384 / 15.12 inch
Depth	Ø 388 / 15.28 inch	Ø 384 / 15.12 inch
Weight with full capacity	37,5 kg / 82.57 lbs	71,5 kg / 157.66 lbs



Water connections	
Feedwater tubing	Tube 1/4" outer diameter
Concentrate tubing	Tube 1/4" outer diameter
Tank Flow tubing (only Smart2Pure 12)	Tube 1/4" outer diameter
Tank back flow tubing (only Smart2Pure 12)	Tube 1/4" outer diameter
Tank overflow tubing (only Smart2Pure 3/6)	Tube 1/4" outer diameter
Dispenser back flow tubing	Tube 1/4" outer diameter
Dispenser flow tubing	Tube 1/4" outer diameter
Tube jumper	Tube 1/4" outer diameter
Front outlet ball valve	Tube 1/4" outer diameter

Electrical connections	
Input voltage	AC 100 – 240 VAC, 50 – 60 Hz, 2.0 A max
Output voltage	DC 24 V, 5.0 A max
System connection	DC 24 V, 120 W
Serial Interface	RS232
Potential free contact	maximum 30V, 2A
Protection class	Class II (external SMPS certified as Class I)

Materials of parts which contact water	
Adjustable pressure retaining valve	NBR = Acrylnitril Butadien Rubber
Pump head	Nylon with glass fibre
UV lamp	High-purity synthetic quartz
UV housing	Stainless steel
Ultrapure cartridge	PP = Polypropylene
UF housing	PC = Polycarbonate
Rinsing solenoid valve	PA = Polyamide
Dispensing valve	PET = Polyethyleneterephthalate
Conductivity measuring cell	POM = Polyoxymethylen, stainless steel
Distributor block	POM = Polyoxymethylen
Connections	POM = Polyoxymethylen
Tubings	PE = Polyethylene
O-Rings	EPDM = Ethylene propylene diene rubber

Accessibility to Smart2Pure systems and pure water tank	
Space on left and right from the side of the system	at least 300 mm / 11.81 inch
Space to the back of the system	at least 200 mm / 7.87 inch
Top space	at least 400 mm / 15.75 inch
Space to front of system	Free accessibility

5 Technical Specifications

Ambient conditions		
	During operation	Storage
Operation area	Indoor rooms	Indoor rooms
Maximum altitude above sea level	up to 2000 m	up to 2000 m
Temperature range	min. +2°C, max +40°C, 80% rel. rH, non-condensing	min. +2 °C, max. +60 °C, 90% rel. rH, non condensing
Line-voltage variation	Not more than +/- 10 % of the line voltage -- (not applicable)	
Transient overvoltages	As usually occur in the supply network -- (not applicable) (overvoltage category II acc. to IEC 60364-4-443) Note: The rated level of transient overvoltage is the withstand impulse voltage acc. to overvoltage category II of IEC 60364-4-443.	
Ventilation requirements	no special requirements	no special requirements
Degree of pollution	2	2
Airborne sound emission		
Sound pressure level	49 db(A)	

The Installation area

NOTICE

The operator is obliged to ensure, that the installation of the water purification unit and its operation are carried out in compliance with all national and international guidelines, applicable and valid for the place of installation. If necessary, measures to protect the drinking water have to be taken by installing appropriate components.

Take the following criteria into consideration when selecting the installation area:

Feedwater pressure (potable tap water) not less than 1 bar (14 PSI) and not greater than 6 bar (87 PSI).

CAUTION

The feedwater pressure must not be allowed to go above 6 bar. Install an additional pressure reducer when the feedwater pressure is higher.

- Minimum air temperature +2 °C
- The surface on which the system is installed must be level and stable not to exceed a maximum of 2% deviation from evenness is recommended.
- A smooth wall is required when the system is to be wall-mounted. Check the statics of the wall or standing surface. The standing or wall surface must be strong enough to hold the system. (for system weight, see '[Accessibility to Smart2Pure systems and pure water tank](#)' on page 21).

CAUTION

Free gravity flow to drain must be ensured.

- An atmospherically floor drain with an outside diameter of 63 mm or 2.48 inch (DN 50 tube) shall be provided.
- Unobstructed draining of the rinsing water to the drain must be ensured. When no floor drain is available, install a water watcher to protect against water damage (available only for Europe).
- A check valve is recommended in the feedwater line to prevent back flow of feedwater from the water system.

- An electric socket with protective connection must be available for connection of the system to the voltage supply.(see '[Electrical connections](#)' on [page 21](#))
- Ample working space must be provided around the system for easy and pleasant replacement of wear and replacement parts and for ease of operation (see '[Accessibility to Smart2Pure systems and pure water tank](#)' on [page 21](#)).
- Easy access for operation and control of the system.

Installation

Content

- “Connections of the Smart2Pure 3/6 system” on page 26
- “Connections of the Smart2Pure 12 system” on page 28
- “Connections of the pure water tank Smart2Pure 12” on page 30
- “Bring your Smart2Pure system into operation” on page 31
- “Connecting an external tank to the Smart2Pure 12 system” on page 34
- “Illustration of drain” on page 35
- “Attaching the wall holder for 30 or 60L pure water tank” on page 36
- “Attaching wall holder for 30L pure water tank” on page 37
- “Attaching wall holder for 60L pure water tank” on page 40
- “Wall mounting” on page 42
- “Mounting the power pack (voltage supply)” on page 43

Connections of the Smart2Pure 3/6 system

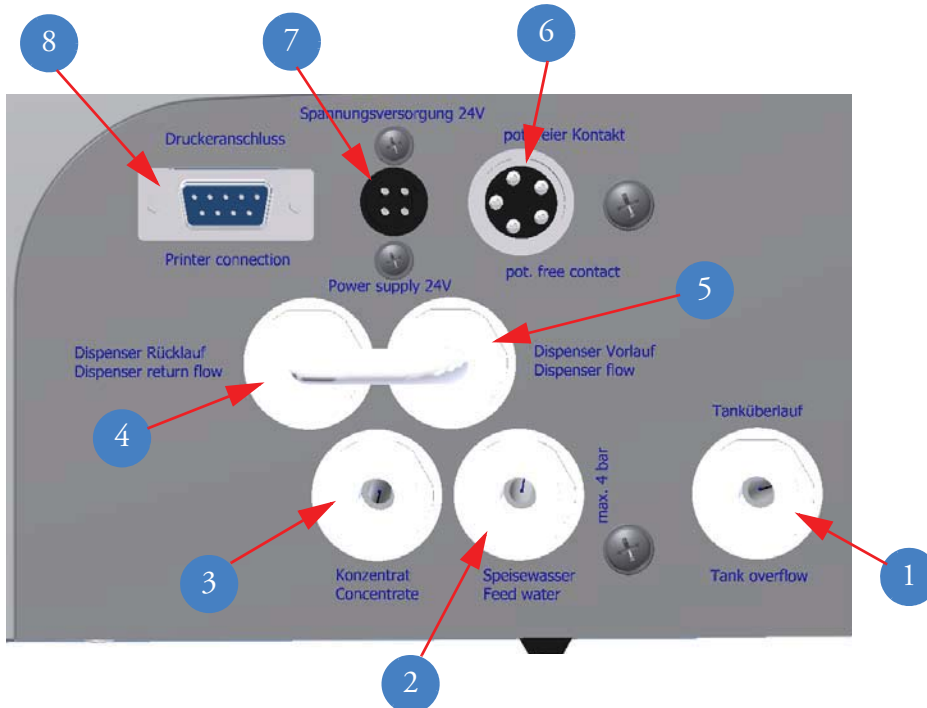
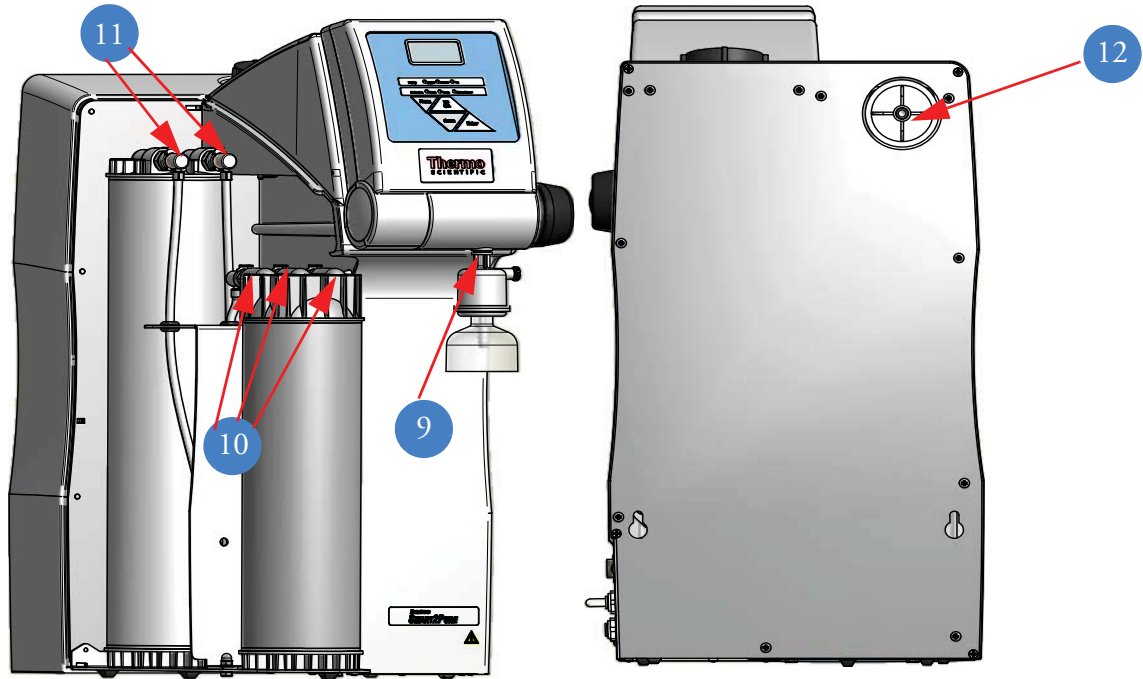

1. Tank overflow connector for outer diameter 1/4" tube
2. Feedwater connector for outer diameter 1/4" tube
3. Concentrate connector for outer diameter 1/4" tube
4. Dispenser back flow connector for outer diameter 1/4" tube for additional hand dispenser
5. Dispenser flow connector for outer diameter 1/4" tube for additional hand dispenser
6. Connector potential free contact 5 pins
7. Power supply connector 24 V DC
8. RS232 printer connection
9. 1/4" thread connector for 0.2 µm final filter
10. Quick connectors for RO/pretreatment cartridge
11. Quick connectors for ultrapure cartridge
12. 1/4 thread connector for sterile vent filter

NOTICE

When you are remove the tube jumper between Pos. 4 and Pos. 5, you have the possibility to connect additionally the accessory hand dispenser, Item No.: 50138221 (purchased separately). This hand dispenser comes with an installation guide.

7 Installation

Connections of the Smart2Pure 12 system

Connections of the Smart2Pure 12 system

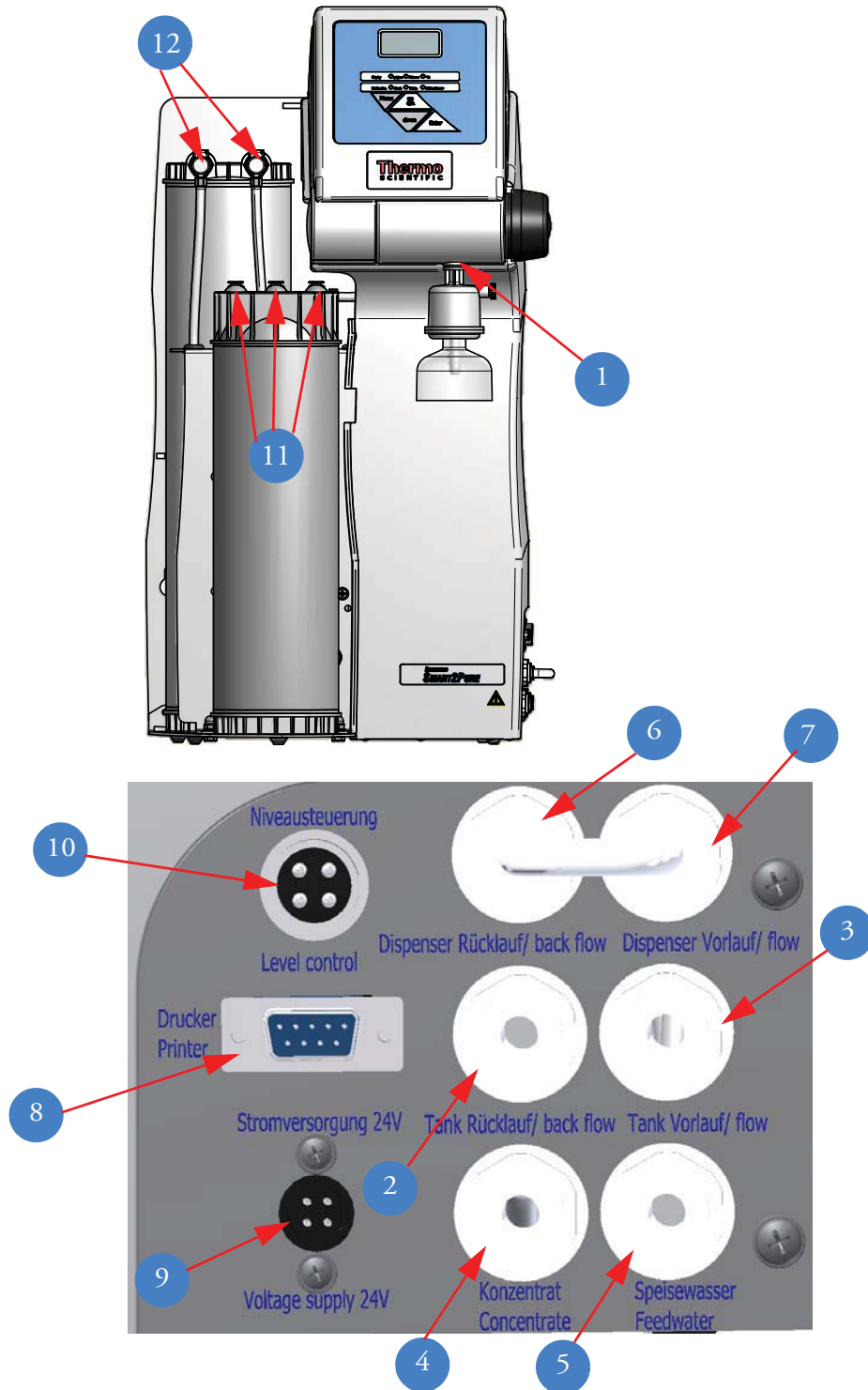

1. 1/4" thread connector for final filter
2. Tank back flow connector for outer diameter 1/4" tube
3. Tank flow connector for outer diameter 1/4" tube
4. Concentrate connector for outer diameter 1/4" tube
5. Feedwater connector for outer diameter 1/4" tube
6. Dispenser back flow connector outer diameter 1/4" tube for additional hand dispenser
7. Dispenser flow connector outer diameter 1/4" tube for additional hand dispenser
8. Optional printer connector
9. Power supply connector 24V DC
10. Level control connector for external pure water tank
11. Quick connectors for RO/pretreatment cartridge
12. Quick connectors for ultrapure cartridge

NOTICE

When you remove the tube jumper between Pos. 6 and Pos. 7, you have the possibility to connect additionally the accessory hand dispenser, Item No.: 50138221 (purchased separately). This hand dispenser comes with an installation guide.

7 Installation

Connections of the Smart2Pure 12 system

Connections of the pure water tank Smart2Pure 12

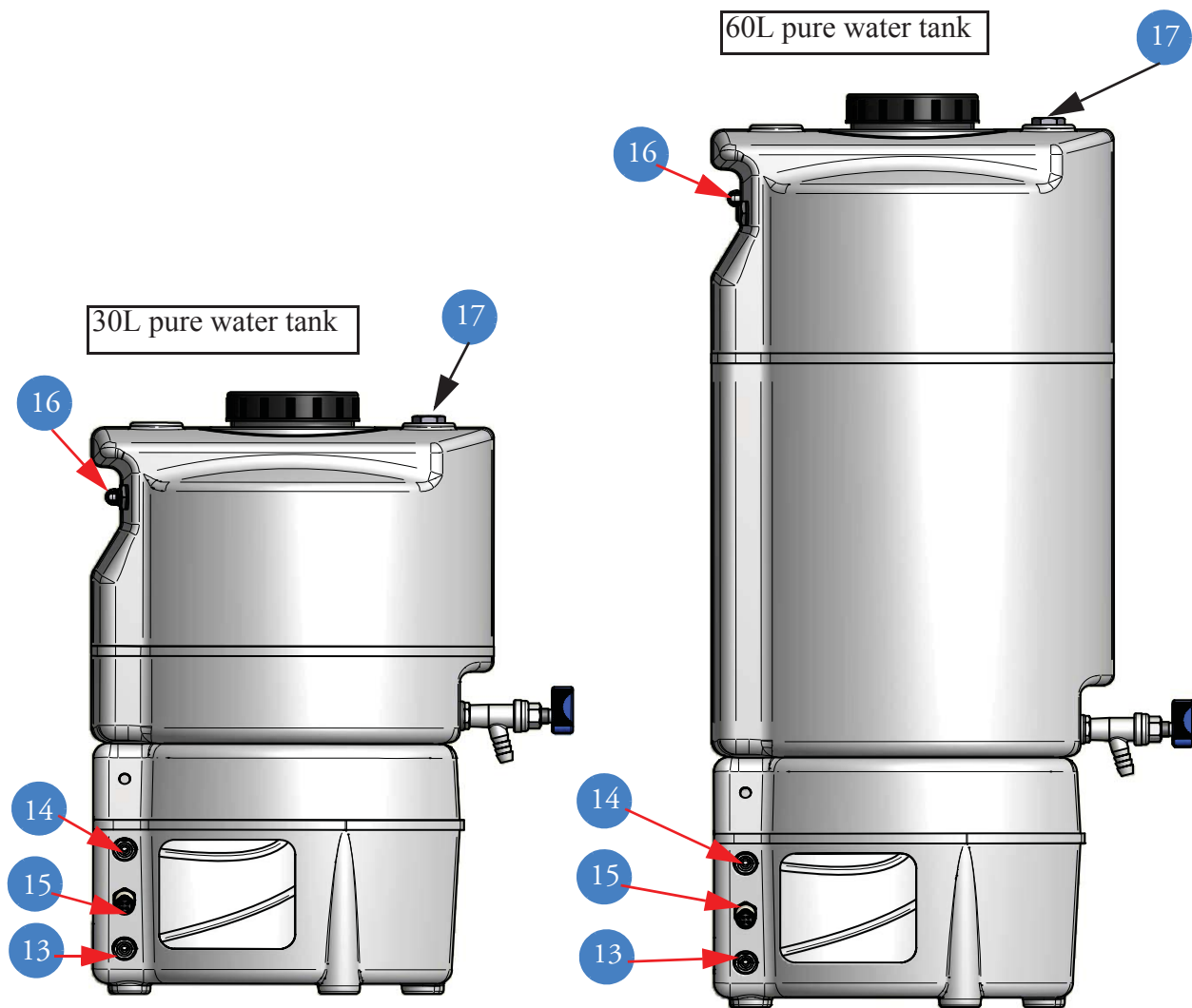

- 13. Tank flow connector for outer diameter 1/4" tube
- 14. Tank back flow connector for outer diameter 1/4" tube
- 15. Level control connector
- 16. Connector for optional sterile overflow
- 17. Connector for optional sterile vent filter

Bring your Smart2Pure system into operation

NOTICE

- After Installation all tubings have to be checked for their correct position on the systems panel and that is no leakage after open the feedwater supply.
- 09.4000 is a required pre-filter system (see “Feedwater requirements” on page 17)
- To avoid tripping, ensure that the tubings and wires do not lay over the floor.

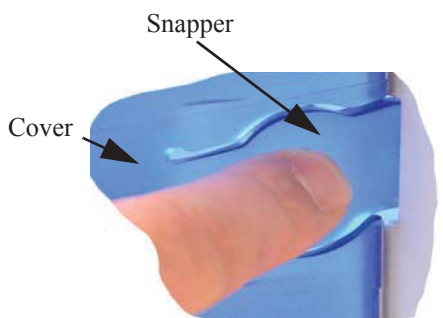
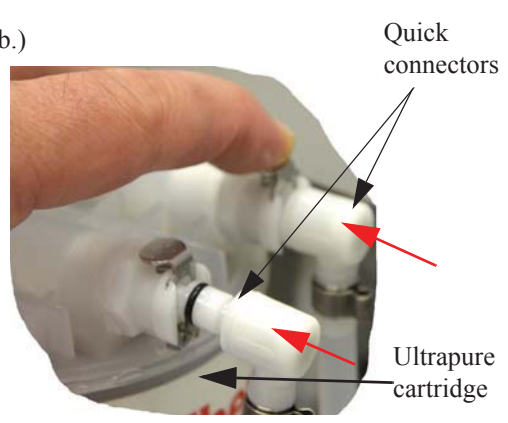
Step	Action	Figure
1	Place the Smart2Pure system at the desired location (on the workbench, under the workbench, or wall-mount). A wall attachment kit is available for wall-mounting (purchasing separately).	See Section “Wall mounting” on page 42.
2	Remove the cover from the ultrapure cartridge by pressing the snapper and pull the cover off towards the front.	 <p>The diagram shows a close-up of a hand's thumb pressing a blue plastic snapper on the side of a blue plastic cover. The cover is being pulled away from the front of the ultrapure cartridge.</p>
3	<p>a. Locate the ultrapure cartridge.</p> <p>b. Place the ultrapure cartridge in the rear section of the system and insert the two quick connectors into the ultrapure cartridge. When you hear an audible click you can be sure that the quick connectors have been inserted correctly.</p>	<p>b.)</p>  <p>The diagram shows a hand inserting two white quick connectors into the back of a white ultrapure cartridge. Red arrows point to the connectors, and a black arrow points to the cartridge. Labels include 'Quick connectors' and 'Ultrapure cartridge'.</p>

NOTICE

The quick connectors are attached to the system in such a manner so as to prevent installing the ultrapure cartridge incorrectly.

7 Installation

Connections of the Smart2Pure 12 system

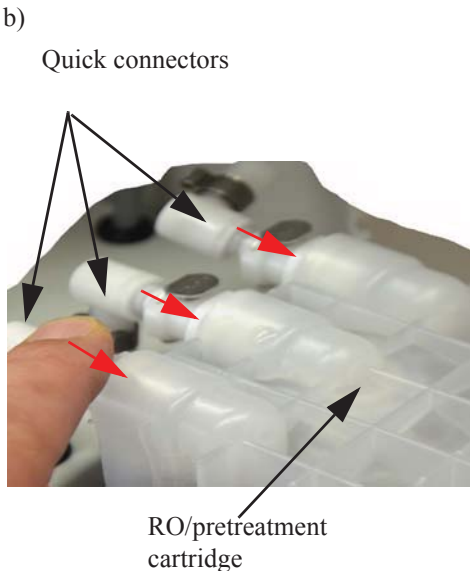
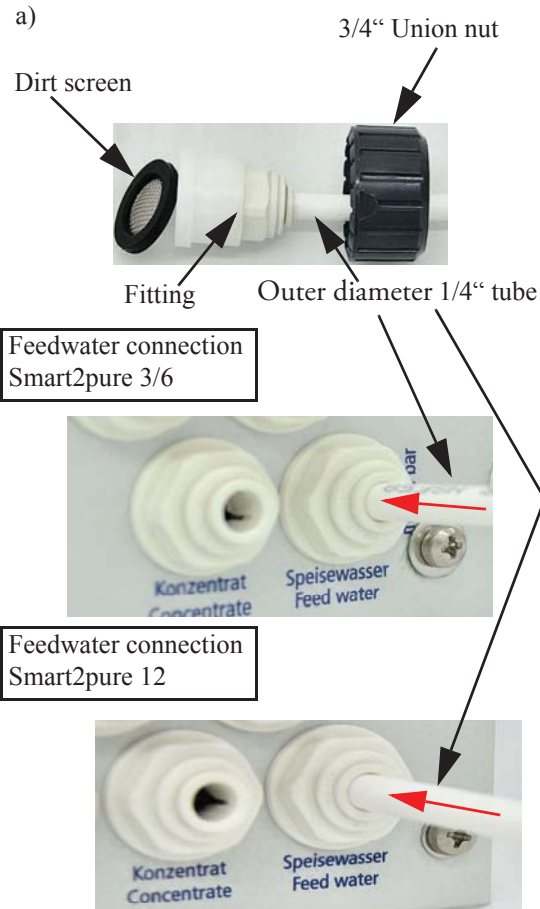
Step	Action	Figure
4	<p>a. Locate the RO/pretreatment cartridge.</p> <p>b. Place the RO/pretreatment cartridge in the front part of the system and insert the three quick connectors into the RO/pretreatment cartridge. When you hear an audible click you can be sure that the quick connectors have been inserted correctly.</p>	 <p>b)</p> <p>Quick connectors</p> <p>RO/pretreatment cartridge</p>
5	<p>a. Use the R3/4" feedwater connecting kit, supplied with the system, to connect the Smart2Pure system with the feedwater tap. Therefore push the R3/4" union nut over the outer diameter 1/4" tube and push in the tube into the fitting and then connect the open end of the outer diameter 1/4" tube to the feedwater connection of the Smart2Pure panel.</p> <p>b. After this screw in the R3/4" union nut with the dirt screen onto the feedwater tap.</p>	 <p>a)</p> <p>Dirt screen</p> <p>Fitting</p> <p>Outer diameter 1/4" tube</p> <p>3/4" Union nut</p> <p>Feedwater connection Smart2pure 3/6</p> <p>Feedwater connection Smart2pure 12</p> <p>Konzentrat Concentrate</p> <p>Speiswasser Feed water</p>

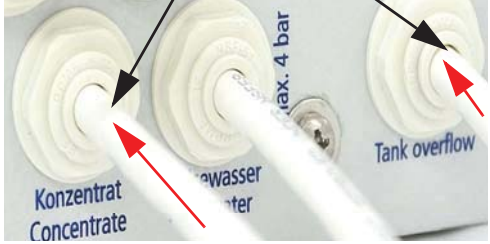
Step	Action	Figure
6	<p>a. Attach on the Smart2Pure 3/6 side panel one piece of outer diameter 1/4" tubing to the concentrate and a second one to the tank overflow outlet. (see "Connections of the Smart2Pure 3/6 system" on page 26)</p> <p>b. Route both AD 1/4" tubes with a free gravity fall to the drain. (see "Illustration of drain" on page 35)</p>	<p>a)</p> 

7

NOTICE

If you are using a Smart2Pure 12 system plug in the outer diameter 1/4" tube into the concentrate plug in the Smart2Pure 12 panel. (see "Connections of the Smart2Pure 12 system" on page 28). Route the outer diameter 1/4" tube with a free gravity fall to the drain. (see "Illustration of drain" on page 35)

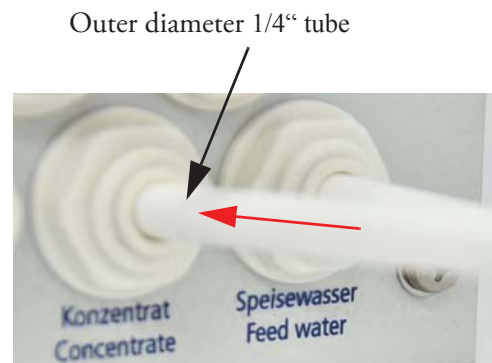

6 Connect the power to the system (see "Mounting the power pack (voltage supply)" on page 43).

7

NOTICE

Before screw in the 0.2 μm final filter onto the 1/4" thread dispensing valve outlet, wait until the tank have the maximum capacity and leave approx 2-run 3 liters pure water from the dispensing valve.

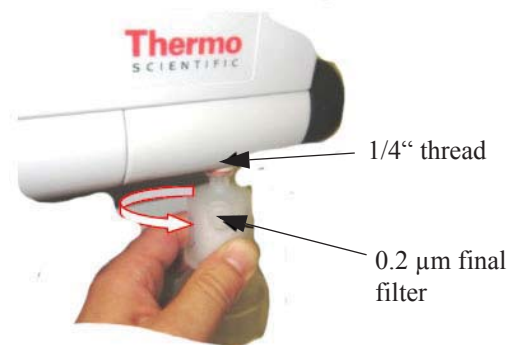

8 Open the feedwater tap and check that there is no leakage on the connectors and tubes.

Connecting an external tank to the Smart2Pure 12 system

NOTICE

- The external pure water tanks are supplied only with the Smart2Pure 12 system.
- The external pure water tanks are available in two different sizes:
 - 06.5040 pure water tank 30L
 - 06.5070 pure water tank 60L
- All connectors for connecting the 30L or 60 L pure water tank to the Smart2Pure 12 system have the same position.
- If you ordered the sterile overflow for pure water tanks, connect the sterile overflow as described in the separate installation guide. If not use a AD 8mm/ 0.31 inch tube to connect the tank overflow to drain as described in this chapter.
- A tank vent filter has to be ordered separately (see “Accessories” on page 87).

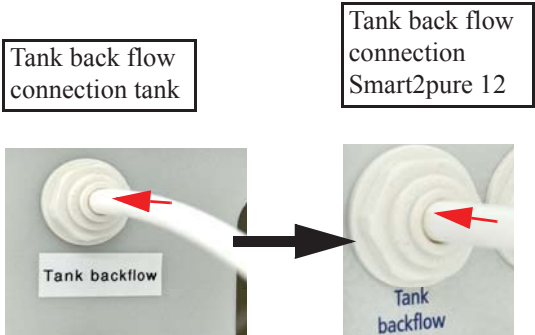
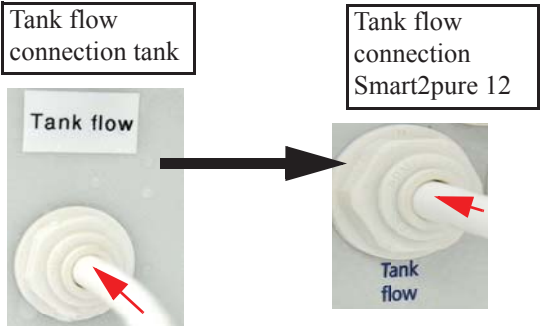
Step	Action	Figure
1	Place the external 30L or 60L pure water tank in the direct vicinity of the Smart2Pure 12 system.	
2	Use the AD 1/4“ tube to connect the tank back flow connector on the pure water tank with the tank back flow connector on the Smart2Pure 12 panel.	
3	Plug in the AD 1/4“ tube to connect the tank flow connector on the pure water tank to the tank flow connector on the Smart2Pure 12 panel.	

Step	Action	Figure
4	Locate the cable for level control on the pure water tank and take it into the level control connector of the Smart2Pure 12 panel.	 <p>Level control connection system panel</p> <p>Level control cable</p>
5	Use a AD 8mm/ 0.31 inch tube to connect the tank overflow fitting connector with the drain. Route the AD 8mm/ 0.31 inch tube with a free gravity fall to the drain. (see “Illustration of drain” on page 35)	 <p>Tank</p> <p>Tank overflow fitting</p> <p>AD 8mm/ 0.31 inch tube</p>
6	Open the feedwater tap and check that there is no leakage on the connectors and tubes.	

Illustration of drain

Illustration of drain siphon for inserting the rinsing water and concentrate outlet tube.

NOTICE

Shorten the rinsing water and concentrate outlet tube to the required length and route it to an atmospherically vented drain.

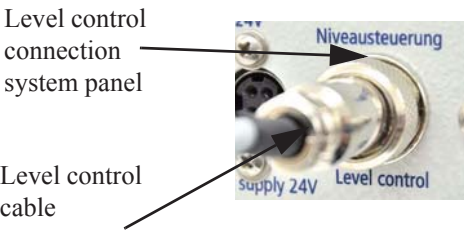
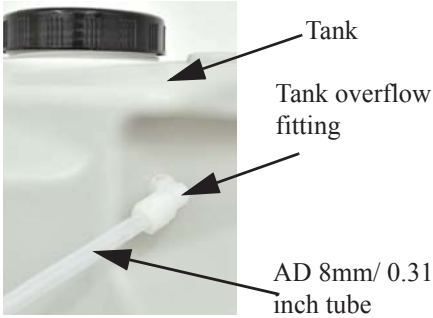
The tubes that run from the Smart2Pure system and the external tank to the drain must be routed with a downward slope and without any kinks or restrictions, as this would result in backing up of the draining water. If a standard drain siphon is in place, the ends of the tubes must be located at least 20 mm/ 0.75 inch above the drain. Attach the tubes in such a manner that they remain in their position.

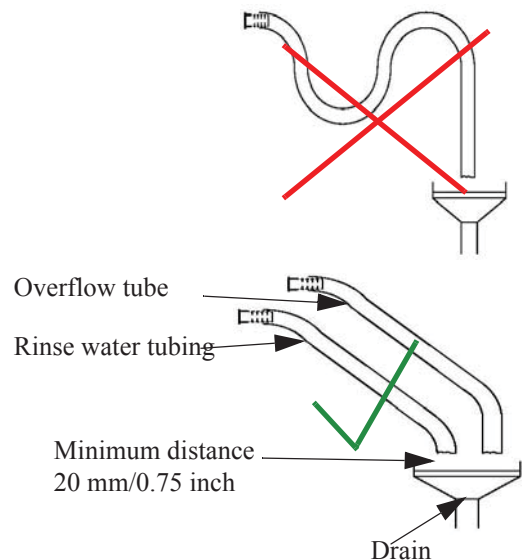

Attaching the wall holder for 30 or 60L pure water tank

NOTICE

! DANGER

- Additional for the 30L or 60L pure water tanks, you have the possibility to attach a wall holder for the pure water tanks (purchasing separately).
- You need for 30L pure water tank the wall holder, Item No.: 06.5015
- For 60L pure water tank you need the wall holder, Item No.: 06.5016
- The wall on which the pure water tank is to be installed or mounted must have an adequate load-carrying capacity (check the capacity and stability of the wall. Weight and dimensions for pure water tanks see “[Dimensions and weight 30L and 60L pure water tank](#)” on page 20).
- Lifting and carried out only the 30L or 60L tank by two person.
- Do not lift up the 30L or 60L tank with full water capacity. Risk of ergonomic postural deformities.

Attaching wall holder for 30L pure water tank

NOTICE

The extend of the delivery from the wall holder for 30L pure water tanks, includes two holder parts:

- one bottom part wall holder with assembly material and
- one upper part holder with assembly material.

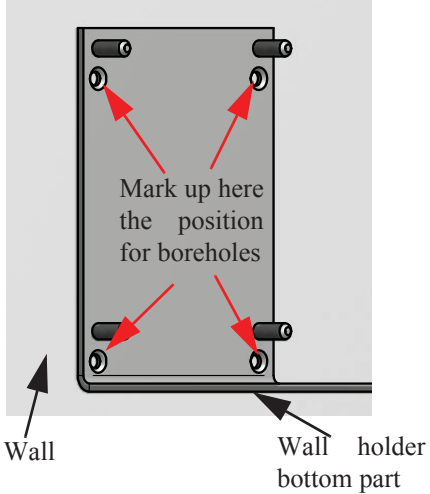
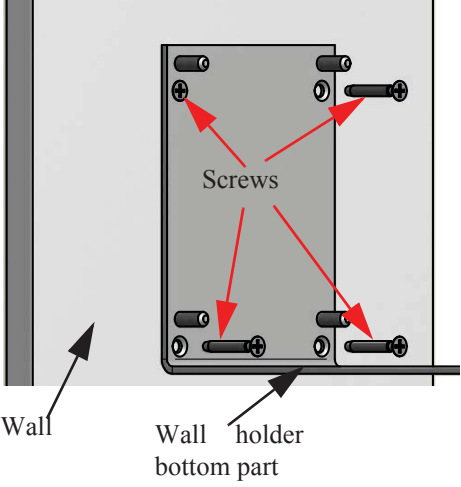
Step	Action	Figure
1	Hold the wall holder bottom part at the desired position on the wall and mark the four boreholes for fixing the wall holder. Then use a 8 mm or 0.31 inch twist drill to make the holes and put in the four S8 plugs which are supplied with the wall holder.	
2	Attach the wall holder bottom part to the wall by screwing in the four supplied screws with a philips screw driver into the wall where you put in the plugs before.	
3	Place the 30L pure water tank onto the mounted wall holder bottom part with two people and then screw in the four supplied M8 hexagon nuts onto the threaded bolts from the wall holder bottom part. (see pictures next side)	

7 Installation

Connections of the Smart2Pure 12 system

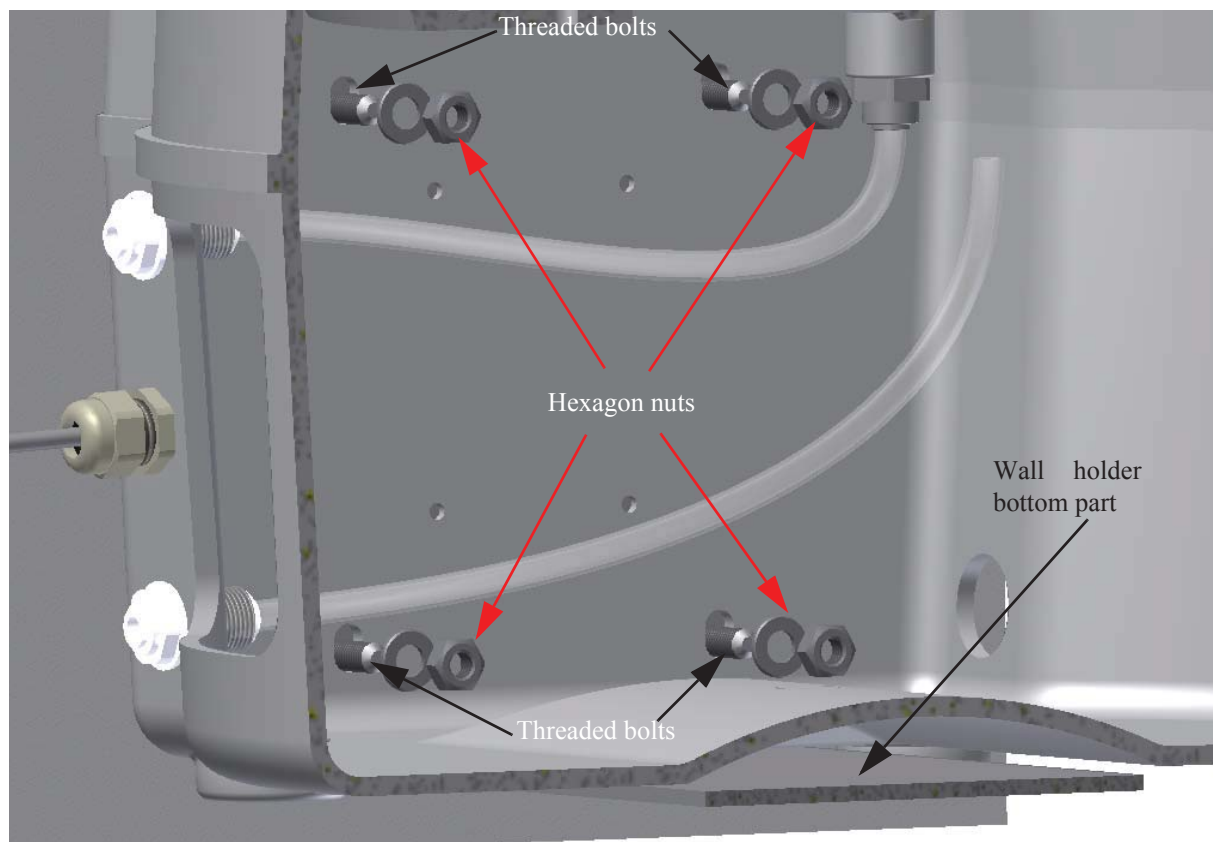
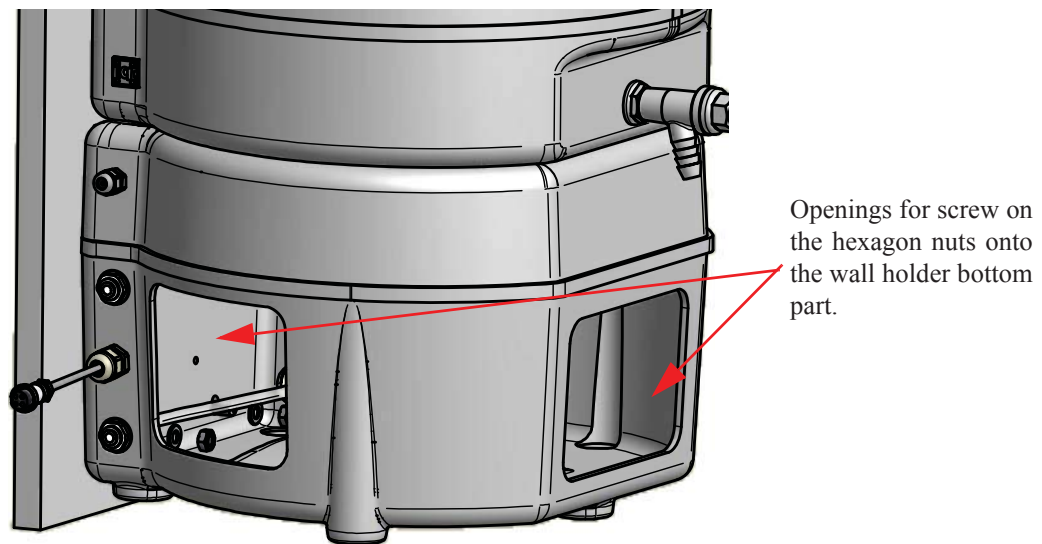

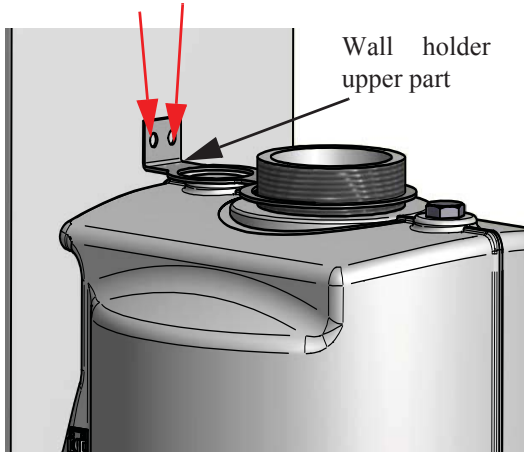
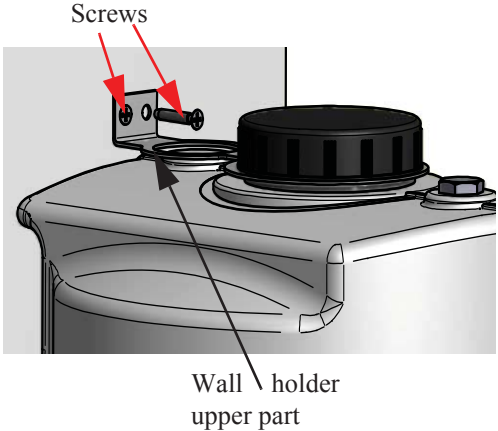
Step	Action	Figure
4	<p>a. Unscrew the lid off the 30L pure water tank.</p> <p>b. Hold the wall holder upper part at the desired position on the wall and mark the two boreholes for fixing the wall holder upper part. Then use a 8 mm or 0.31 inch twist drill to make the holes and put in the four S8 plugs which are supplied with the wall holder.</p>	<p>b.)</p>  <p>Mark up here the position for boreholes</p> <p>Wall holder upper part</p>
5	<p>Screw in the two screws with a Phillips screw driver into the wall where you have put in the plugs before.</p>	 <p>Screws</p> <p>Wall holder upper part</p>
6	<p>After mounting the complete wall holder connect the tubing and level control cable as described at chapter “Connecting an external tank to the Smart2Pure 12 system” on page 34.</p>	

NOTE

To prevent contamination of the 30L pure water tank when the lid is unscrew and mounting works, screw on the lid after you have placed the wall holder upper part on the pure water tank as described above.

Attaching wall holder for 60L pure water tank

Step	Action	Figure
------	--------	--------

1 Locate the two metal brackets and baseplate and screw in as shown in the diagram the six countersunk screws and hexagon nuts supplied with the brackets.

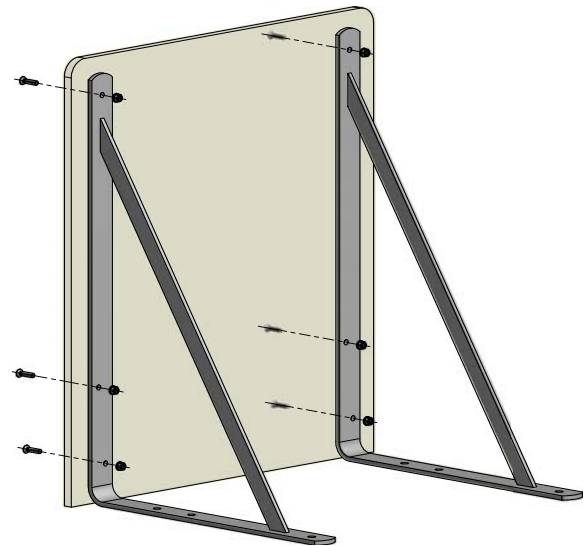

2 Hold the wall holder at the desired position on the wall and mark the six boreholes for fixing the wall holder. Then use a 8 mm or 0.31 inch twist drill to make the holes and put in the six S8 plugs which are supplied with the wall holder.

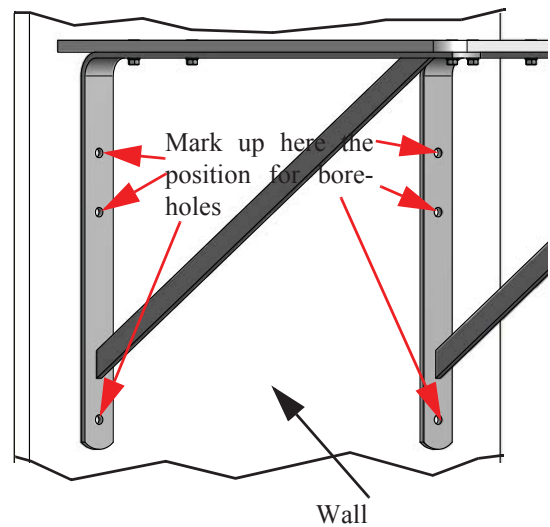

Step	Action	Figure
------	--------	--------

3	Attach the wall holder to the wall by screwing in the six supplied countersunk screws with a Phillips screw driver.	
---	---	--

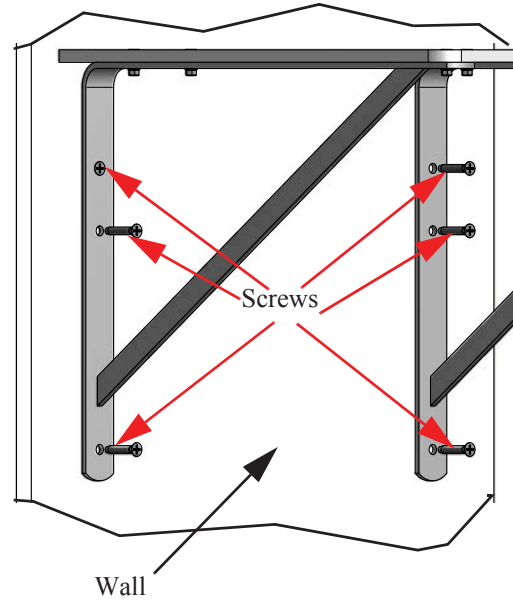

4	Place the 60L pure water tank with two people on the wall holder and repeat the steps 4, 5 and 6 in section “Attaching wall holder for 30L pure water tank” on page 37.	
---	---	--

Wall mounting

NOTICE

CAUTION

You can also mount your Smart2Pure 3/6 or Smart2Pure 12 system on the wall. To do this, use the wall-mounting fixture included in the accessories (purchased separately *Item No.: 09.2212*). Before you begin mounting the system on the wall you must check the strength of the wall to ensure that it is suitable for supporting the system (see “[Dimensions and weight Smart2Pure 3/6](#)” on page 18 and “[Dimensions and weight of Smart2Pure12](#)” on page 19 for the system).

The screws and anchors supplied with the wall-mounting brackets are only suitable for attaching the wall-mounting brackets to a concrete wall or a solid (masonry) wall.

Step	Action	Figure
1	Use the wall-mounting brackets to mark the anchoring points with a pen on the wall at the location where the holes are to be drilled for the wall-mounting bracket. Use an 8 mm/ 0.31 inch drill bit to drill the holes.	See figure below.
2	Insert the three S8 Nylon anchors into the holes and then use the three wood screws to firmly screw the wall-mounting brackets into place.	
3	Lift the system and hang the back of it on the wall-mounting brackets.	

CAUTION

Always lift and carry the system in tandem (two people), never alone. Lift the system at the two bottom corners.

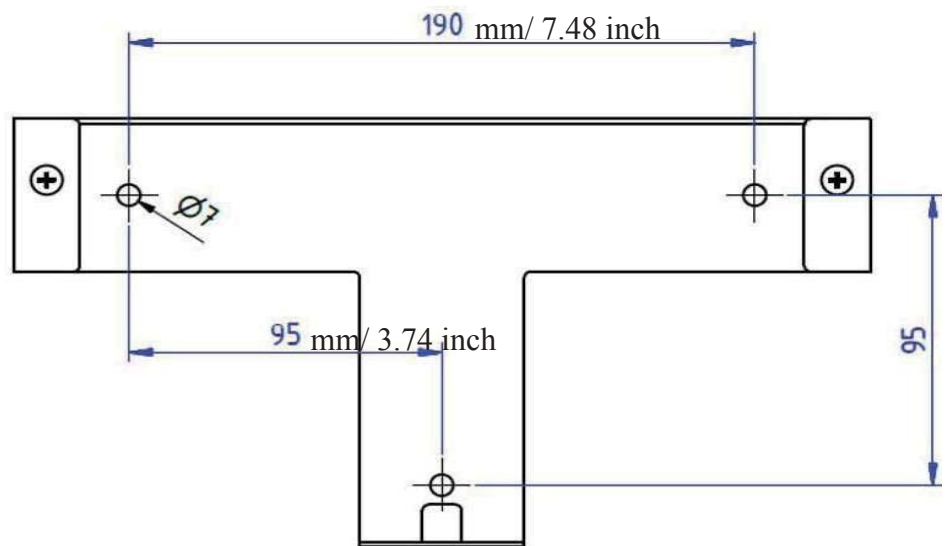

Mounting the power pack (voltage supply)

NOTICE

Whenever possible, mount the power pack on the wall to the left or right of the ultrapure water system where it is freely accessible and not come in contact with water for get wet.

DANGER

Take caution to ensure that the suitable plug and the power cable do not get wet. Mount the power pack with dry hands. Risk of an electrical shock.

Step	Action	Figure
1	Remove the protective foil on the back of the universal holder and from the universal adapter and attach the universal holder to the center of the back of the main adapter.	<p>The figure shows two components, a dark green universal adapter and a dark green universal holder, with arrows pointing to their respective protective foils. Below, a photograph of the black mains adapter has a red circle around its back panel, with an arrow pointing to the universal holder being attached to its center.</p>
2	Attach universal adapter to a smooth wall surface with supplied screws or with glue (not provided).	<p>The diagram shows a black rectangular universal adapter mounted on a wall. The wall surface is represented by a jagged line, and an arrow points from the label 'Wall surface' to this line. Another arrow points from the label 'Universal adapter' to the device itself.</p>

7 Installation

Connections of the Smart2Pure 12 system

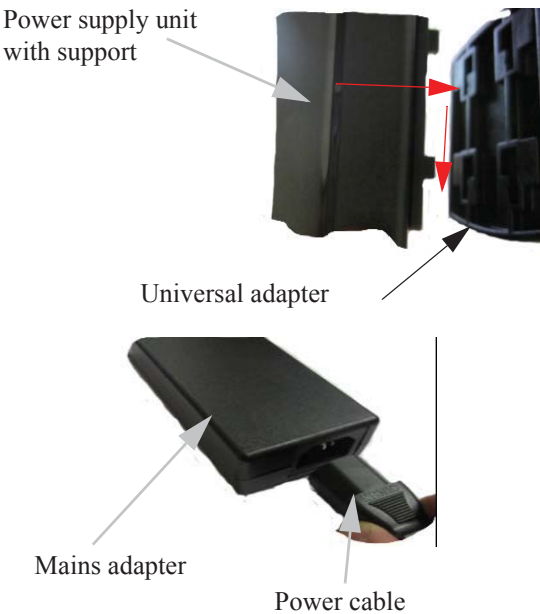
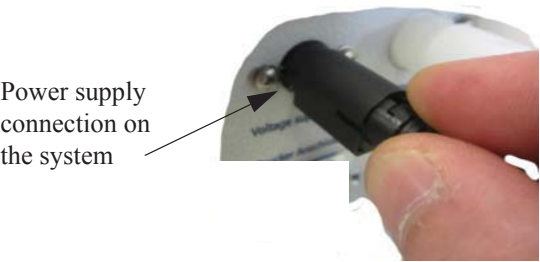
Step	Action	Figure
3	<p>a. Take the power supply unit and press it with the attached universal holder onto the wall and then slide it down (see red arrows).</p> <p>b. Plug the power cable into the power supply unit.</p>	 <p>The figure consists of two parts. The top part shows a black power supply unit with a support bracket attached to its back. Red arrows indicate the unit being pressed against a wall and then sliding down. Labels include 'Power supply unit with support' and 'Universal adapter'. The bottom part shows a black mains adapter with a power cable plugged into its side. Labels include 'Mains adapter' and 'Power cable'.</p>
	<p>⚠ DANGER</p> <p>Do not bring the power pack in contact with water. Risk of an electrical shock..</p> <p>NOTICE</p> <p>The removable power cable must always face downward when the power supply unit has been mounted.</p>	
5	<p>Now, connect the power supply unit to the 'Power supply' connection on the right side of the Smart2Pure 3/6 or Smart2Pure 12 system. Next plug the power supply to a grounded 100 - 240V, 50/60 Hz power outlet.</p>	 <p>The figure shows a close-up of a hand plugging a black power supply connector into a port on a white system component. The port is labeled 'Power supply connection on the system'.</p>
6	<p>The system is now ready for work.</p>	

Mounting the ball valve to the Smart2Pure system

NOTICE

Delivered with the assembly kit is a ball valve with a t-connector to have the opportunity to dispensed pure water ASTM Type II quality from the internal or external tank from the Smart2Pure system.

Proceed as follows to do this action.

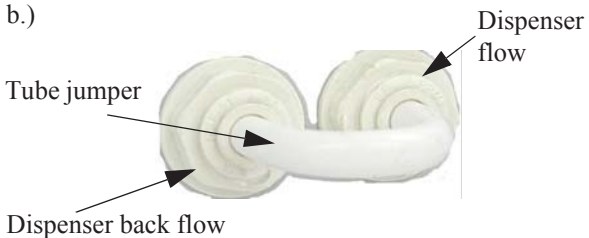
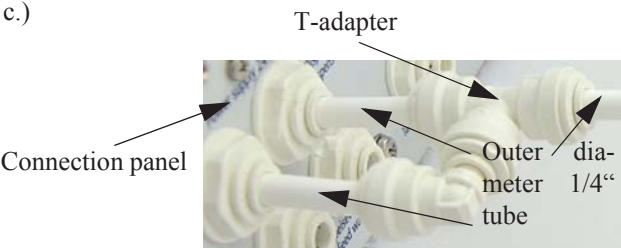
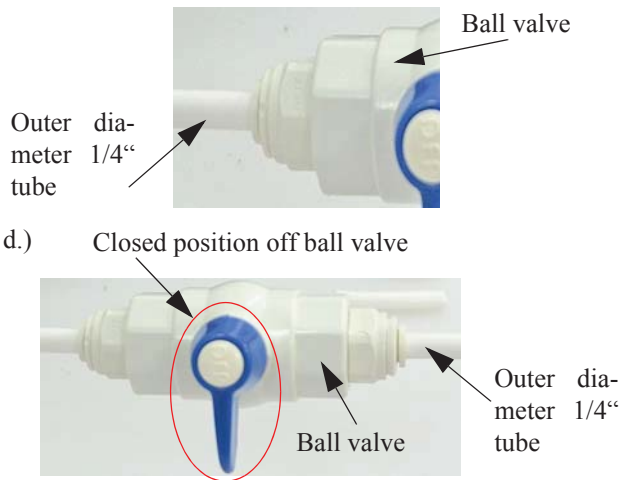
Step	Action	Figure
1	Switch the system off. (unplug the main power supply)	
2	<p>a. Locate the ball valve, the t-adapter and the outer diameter 1/4" tube.</p> <p>b. Remove the tube jumper from the connection panel of the system.</p> <p>c. Cut from the outer diameter 1/4" tube two tubes with a length of 80 mm/ 3.2 inch and attach the tubes into the t-adapter and the connection panel. Attach the ball valve with a third outer diameter 1/4" tube to the t-adapter.</p> <p>d. Additionally attach a fourth outer diameter 1/4" tube to the other connection of the ball valve.</p>	<p>b.)</p>  <p>c.)</p>  <p>d.)</p> 
3	Switch the system on. (Connect main power supply)	

NOTICE

You can choose the length of the outer diameter 1/4" tubes beginning from the t-adapter for the ball valve by yourself.

7 Installation

Connections of the Smart2Pure 12 system

Flow chart

NOTICE

The following flow chart describes the Smart2Pure Systems with full equipment (ultrafilter, UV-lamp). Depending on your Smart2Pure system configuration the UV-lamp or ultrafilter are inapplicable. The flow chart direction remains as described in the flow diagram.

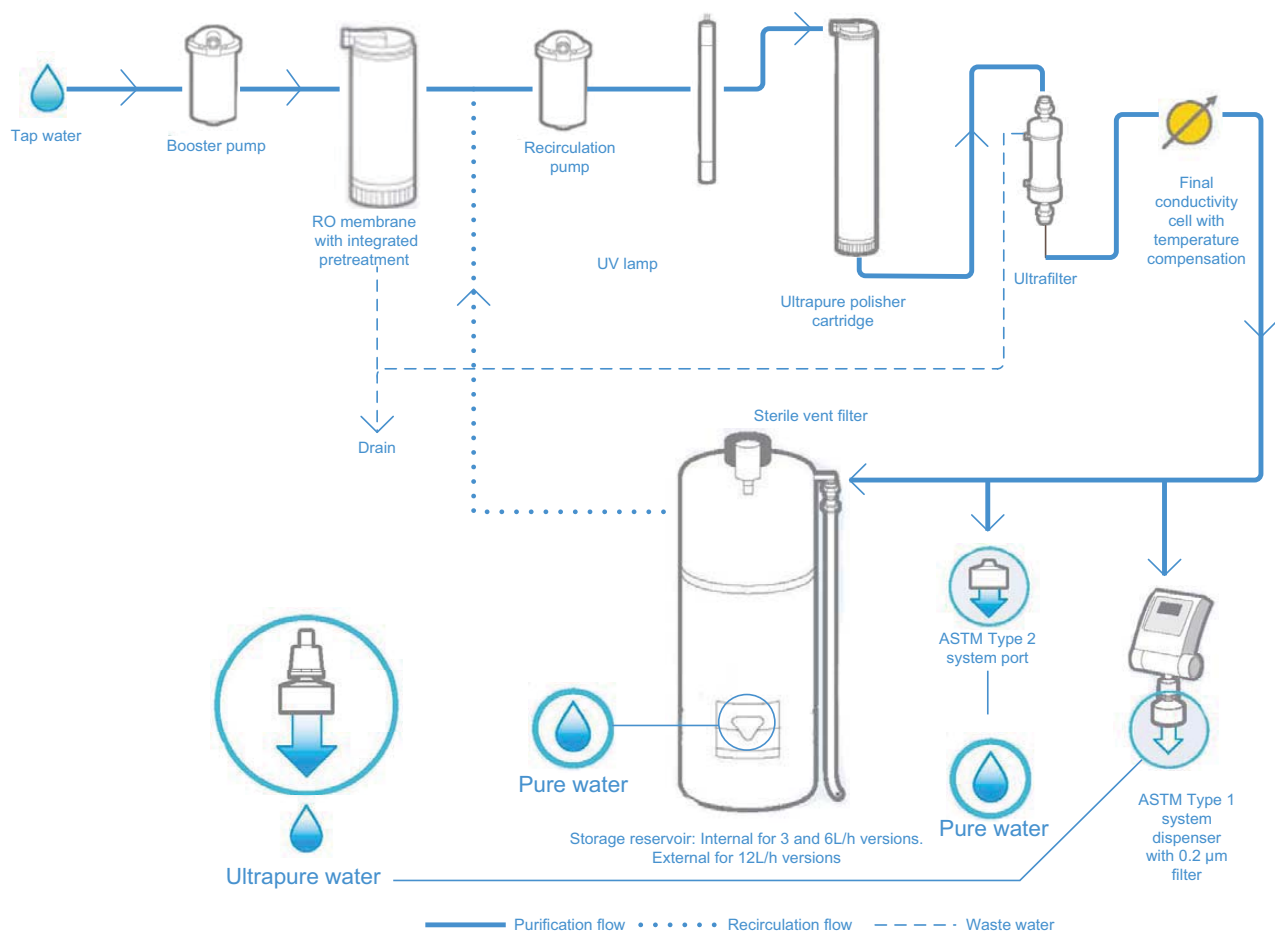

8 Flow chart

How the Smart2Pure system functions

When the system is in operation, tap water with a maximum pressure of 6 bar flows into the system and is pumped by pressure booster pump 1 through the RO/pretreatment cartridge. The RO/pretreatment cartridge splits the feedwater by reverse osmosis technology in “permeate and “concentrate“ water flow. The concentrate water flows to drain. The permeate of the reverse osmosis membrane flows into the internal 5L tank or by Smart2 Pure 12 systems into the external pure water tank. If the internal or external pure water tank is filled with maximum capacity with water of ASTM Type II, the feedwater solenoid valve is closed by a level switch and prevents that no more water flows into the system.

After open the dispensing valve the pure water from the tank flows through the UV bulb (*only systems with UV*), ultrapure cartridge and the ultrafilter (*only systems with UF*). ASTM Type I water can be dispensed through the 0.2 µm final filter on dispensing valve and ASTM Type II water when you have connect the accessory hand dispenser on the connection panel of the system.

The water in the internal or external tank is recirculated at regular intervals through the pressure booster pump 2 to ensure the constant quality of pure water ASTM Type II. A level switch monitors the water level inside the tank.

ASTM Type II water can be dispensed from the side outlets of internal tank from the connection panel or from the front valve of the external tank.

9 How the Smart2Pure system functions

Initial start up

Contents

- “Putting the system into operation” on page 52
- “Dispensing water from the dispensing valve” on page 54
- “Venting the 0.2 μm final filter” on page 54

Putting the system into operation

NOTICE

The system must be warmed up or cooled down to room temperature before being put into operation.

CAUTION

Check that all connections have been made as described in Chapter 7 “Installation” on page 25 or shown in the bottom diagram.

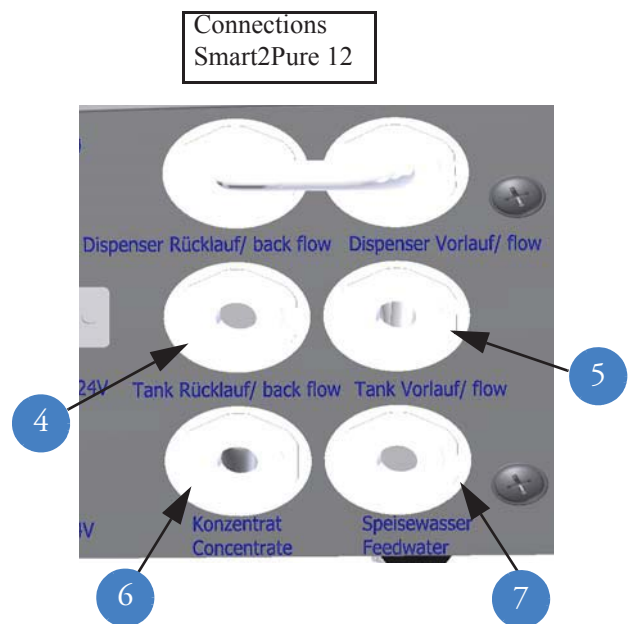
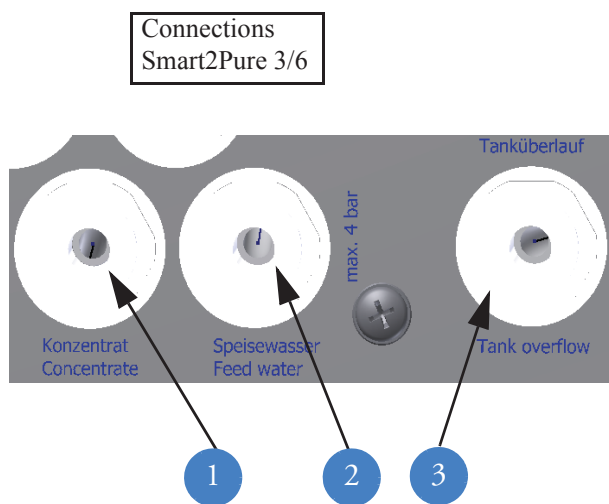

1. Concentrate connector for outer diameter 1/4" tube
2. Feedwater connector for outer diameter 1/4" tube
3. Tank overflow connector for outer diameter 1/4" tube

4. Tank back flow connector for outer diameter 1/4" tube
5. Tank flow connector for outer diameter 1/4" tube
6. Concentrate connector for outer diameter 1/4" tube
7. Feedwater connector for outer diameter 1/4" tube

- Put in the voltage supply from the power pack into the power supply from the system on the connection panel.

NOTICE

- After connecting the power supply into the system, a brief self test is starting for approx 5 minutes. After the brief self test the system begins to produce pure and ultrapure water.
- If the tank content of the Smart2Pure 3/6 system is empty it is possible that air is coming from the tank into the ultrafilter (only systems with ultrafilter). Thereby you can not dispense water from the sampling tap on the system. Proceed as follows in such a case:
 - unplug the main plug and wait 5 seconds before you put the main plug back.
 - Wait approx 10-15 minutes before you start with dispensing water from the sampling tap.
- Wait until the tank filling has been completed. This could take approx. 1.5 to 3 hours with a Smart2Pure 3/6 system. With a Smart2Pure 12 system this could take up to 2.5 hours to fill a 30L tank and about 5 hours to fill a 60L tank. Discard the content of first tank filling.
- Before screw in the sterile filter onto the dispensing valve outlet, wait until the tank have the maximum capacity and leave approx 2-run 3 liters pure water from the dispensing valve.
- Screw in the sterile filter.

Dispensing water from the dispensing valve

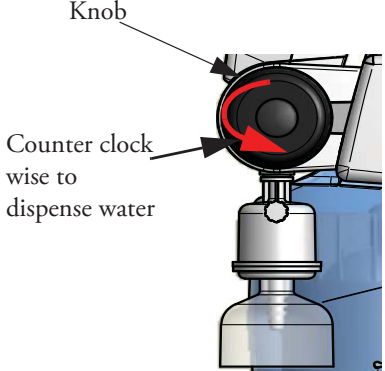
Step	Action	Figure
1	<p>Turn knob counter clock wise to dispense water.</p> <p>Water flow out of unit and can be adjusted with turning the knob. Turn the knob clockwise to slow down or stop water flow.</p> <div data-bbox="272 688 966 772" style="border: 1px solid black; padding: 5px; margin-top: 10px;"> <p>CAUTION Do not over tighten knob once flow stops, doing so could damage dispensing valve.</p> </div>	

Venting the 0.2 µm final filter

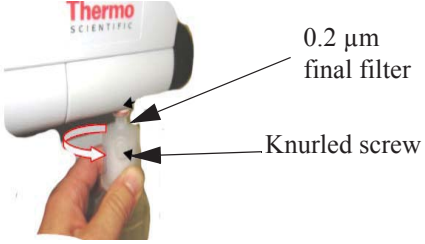
Step	Action	Figure
1	<p>The first time you dispense pure water at the main dispenser through the 0.2 µm final filter, open the white knurled screw.</p>	
2	<p>Do not close the knurled screw until pure water runs out of the opening at the knurled screw continuously. Rinse about 500 ml of water through the final filter.</p>	

Operating Elements

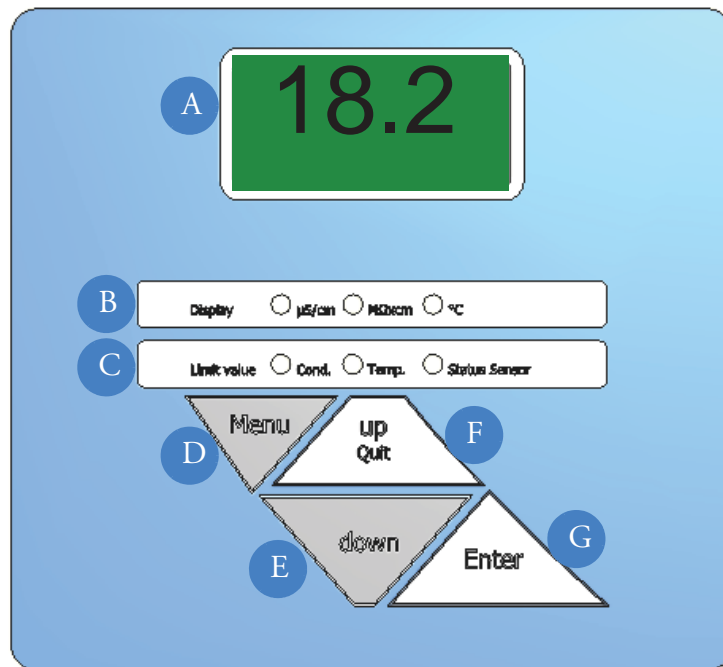

A = Display shows the actual value of final product water resistivity/ conductivity and temperature. If the measurement range end value is exceeded ($>199 \mu\text{S}/\text{cm}$ or $>0.005 \text{M}\Omega\text{-cm}$), then $\div 200$ is shown in the display.

B = Second line shows the currently running measurement mode in $\mu\text{S}/\text{cm}$, $\text{M}\Omega\text{-cm}$ and $^{\circ}\text{C}$.

C = Third line shows the “Limit value Cond.”, “Temp.” and “Status Sensor”. The “Limit value Cond.” LED’s will report any value, out of its limit, immediately. Also the calling up of submenus for limit settings is indicated. The “Status Sensor” LED shows any error at the conductivity and temperature measuring cell.

D = Menu button: switches the Menu to the next submenu.

E = Down button: decreases adjustable values.

F = up/Quit button: increases adjustable values, quits acoustic alarms.

G = Enter button: confirms changes, allows to adjust the cursor.

11 Operating Elements

System control

Contents

- “Menu” on page 58
- “Mono/dual measurement mode” on page 58
- “Setting the limiting value for conductivity” on page 59
- “Setting the limiting value for temperature” on page 60
- “Error message and acoustic error signal” on page 61
- “Communication” on page 61
- “Potential-free contact” on page 62

Menu

The menu consists of three sub-points:

1. Switching to dual mode together with selection of the measurement unit for the conductivity measurement.
2. Setting the product water conductivity limit value.
3. Setting the temperature limiting value.

Mono/dual measurement mode

NOTICE

This following combinations are possible in the Mono/dual measurement mode:

- adjusted resistance value MΩ·cm: “c” and “ct”
- adjusted resistance value μS/cm: “c” and “ct”

Mono measurement mode:

- In this mode only the conductivity is displayed. The temperature can be read when the “Enter” button is pressed.

Dual measurement mode:

- In this mode, temperature and conductivity are shown alternating in a 2-second tact. The LED for the unit switches with the display.

Step	Action	Picture
1	Press the „Menu“ button once then the display shows you the last adjustment measurement mode (green LED lights up). The first line shows the selected unit of measurement resistance value (factory adjustments in MΩ·cm).	<p>The diagram shows a 'Menu' button being pressed. An arrow labeled 'Display shows' points to a digital display showing the number '18.2'. Below the display is a unit selection bar with three options: 'μS/cm', 'MΩ·cm' (which is selected with a green dot), and '°C'. Labels 'Display' and 'First line' point to the display and the unit bar respectively.</p>
2	Use the “up/Quit“ and “down“ button to choose the resistance value for measuring mode (μS/cm or MΩ·cm) and then choose the mono measurement mode “c” or dual measurement mode “ct”.	<p>The diagram shows two buttons: 'up/Quit' and 'down'. An arrow labeled 'Display shows' points from the 'down' button to a display showing 'ct'. A second arrow labeled 'or' points from the 'up/Quit' button to a display showing 'c'. This indicates that pressing 'down' leads to 'ct' and pressing 'up/Quit' leads to 'c'.</p>

Setting the limiting value for conductivity

NOTICE

- The limiting value can only be set in $\mu\text{S}/\text{cm}$ and is factory adjusted to a value of $0.1 \mu\text{S}/\text{cm}$.
- Setting range: $0.055 - 30 \mu\text{S}/\text{cm}$, basic setting: $0.1 \mu\text{S}/\text{cm}$

Step	Action	Picture
1	Press the “Menu” button twice to enable the limiting value for the conductivity to be set (red LED lights up).	
2	Use the “up/quit” and “down” button to increase or reduce the value. With the “Enter” button you switch to the next digit. After finishing adjustment press “Enter” to confirm the value.	
3	Press the “Menu” button twice to return to the operating mode.	

Setting the limiting value for temperature

NOTICE

- The limiting value is factory adjusted to a value of +35°C.
- Setting range: 10°C - 40°C, basic setting: 35°C

Step	Action	Picture
1	Press the “Menu“ button three times to enable the limiting value for the temperature to be set (red LED lights up).	
2	Use the “up/quit“ and “down“ button to increase or reduce the value. With the “Enter“ button you switch to the next digit. After finishing adjustment press “Enter“ to confirm the value.	
3	Press the „Menu“ button once to return to the operating mode.	

Error message and acoustic error signal

NOTICE

- If the limiting value of the conductivity or temperature are reached, in the display shows “ - - “ or “ ÷ 200 “, the red LED in the second line is lighting up and additionally after approx. 5 minutes an acoustic signal will sound.

Error

Lights up LED in second line and acoustic signal

Limiting value of conductivity is reached

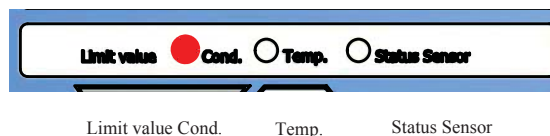

Limiting value of temperature is reached

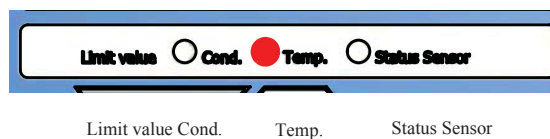

Limiting value of conductivity and temperature together is reached

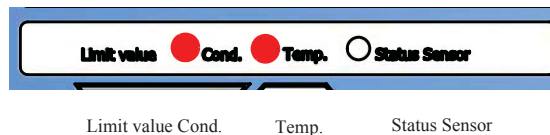

Measuring cell signal incorrect

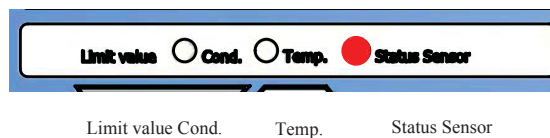

Communication

A printer can be connected to the RS232 interface for print out of measured values. The values of the conductivity or temperature are given out at the serial interface separated by a comma. Automatically the conductivity is scaled to three significant places. Output is made 1x per hour.

When the system is in operation mode, a press on the „down“ button triggers a measured value output at the serial interface.

Print out example: 18.2 MΩ·cm, 23.4°C

Potential-free contact

The system is equipped on the systems panel with a potential free contact for control external equipment. The maximum connected load is 30V, 2A

The Pin assignment of the 5 pin socket is:

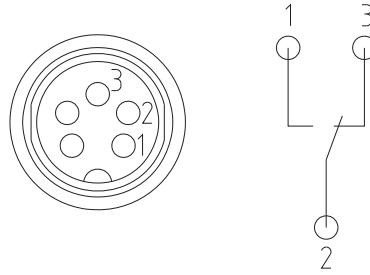

Maintenance

Content

- "Maintenance Intervals" on page 64
- "Replacing the ultrapure cartridge" on page 65
- "Replacing the RO/pretreatment" on page 66
- "Cleaning" on page 68
- "Changing the ultrafilter" on page 63
- "UV-reactor assembly" on page 73
- "Replacing the UV lamp" on page 74
- "Replacing the 0.2 µm final filter" on page 76
- "Autoclaving the 0.2 µm final filter" on page 76

Regular servicing of the system ensures that the quality of the treated water will remain constant. To ensure that your system is serviced properly we recommend that you obtain a maintenance contract with a service company authorized by the manufacturer. You can then be certain that your system will have a high degree of operational reliability and dependability.

To ensure that your system functions without any errors it must be checked, maintained and serviced at regular intervals, as described in these operating instructions. The operating instructions must therefore be kept in an easily accessible location for anyone who is using or servicing the system. Calibration of the conductivity may only be performed by a service technician authorized by the manufacturer.

Cleaning of the system should be performed annually. Cleaning must also be performed in the event of a high bacteria content or impurities in the product water and when changing the ultrapure cartridge.



Checks or maintenance work on electrical equipment are only to be carried out by qualified electricians.

Unplug the system from the power outlet for all maintenance work on the system.

Maintenance Intervals

Wear parts must be replaced in accordance with the following table. The intervals have been established for the user and depend on the actual, exact water quality and the volume of water that is used daily.

Material	Flow chart no.	Item No..	Interval	Other problems
Ultrapure cartridge	F1	09.1020	12 months	Or when the pure water limit value is exceeded, whichever occurs first. Bacteria growth may occur in the resin when the system has been in use over an extended period.
Sterile filter 0.2 µm	F2	09.1003	12 months	Or the flow rate is markedly slower
Ultrafiltration membrane (UF)	F3	50133981	24 months	Or if there is endotoxin breakthrough in product water or when the water flow rate is markedly slower.
UV lamp	UV1	09.1002	24 months	Or when UV lamp does not light.
RO/pretreatment cartridge	F6	09.2003 09.2006 09.2012	12 months	Or when the ultrapure cartridge has shorter life time than expected.

Please note that the lifetime of the wear parts is a direct function of the quality of the feedwater and the daily volume of water that is used.

Replacing the ultrapure cartridge

NOTICE

Replace the ultrapure cartridge with a new one when the ultrapure water conductivity is purity dropped below acceptable levels or the replacement interval is due.

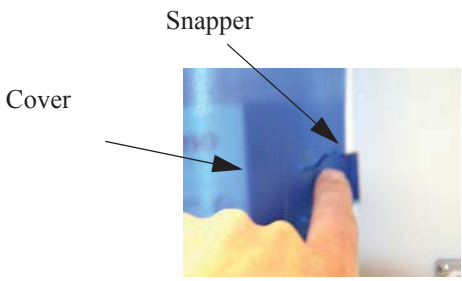
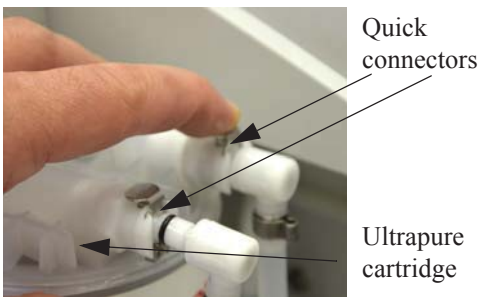
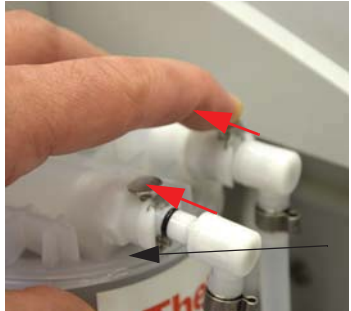
Step	Action	Figure
1	Switch the system off (unplug main power supply).	
2	Remove the cover from the ultrapure cartridge by press the snapper and pull the cover toward the front to remove it.	
3	Press on the two quick connectors at the inlet and outlet of the ultrapure cartridge and remove the used cartridge from the system.	
4	We recommend performing a cleaning when an existing ultrapure cartridge is replaced.	<div data-bbox="954 1323 1250 1396" style="background-color: #0056b3; color: white; padding: 5px; text-align: center; font-weight: bold;">NOTICE</div> <p>Refer to section "Cleaning" on page 68 for an explanation of how to perform cleaning.</p>
5	Locate the new ultrapure cartridge and insert the cartridge into the system.	
6	Insert the quick connectors into the connecting points on the ultrapure cartridge. When you hear an audible click you can be sure that the quick connectors have been inserted correctly.	<div data-bbox="284 1743 576 1816" style="background-color: #0056b3; color: white; padding: 5px; text-align: center; font-weight: bold;">NOTICE</div> <p>The quick-connectors are attached to the system in such a manner so it is to prevent any confusion (switching).</p> 

Step	Action	Figure
7	Put the cover for the ultrapure cartridge back in place and switch the system on (connect the main power supply).	
9		

NOTICE

Discharge the first 5 liters.

Replacing the RO/pretreatment

NOTICE

Only replace the RO/pretreatment cartridge when the maximum limit for the feedwater has been exceeded, when you cannot extract any water from the sampling tap or when the replacement interval is due.

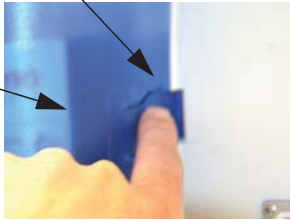
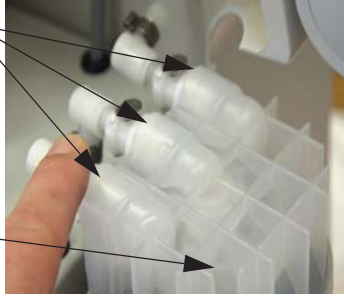
Step	Action	Figure
1	Switch the system off (unplug main power supply).	
2	Remove the cover over the RO/pretreatment cartridge by pressing the snapper and pull the cover forward.	 <p>Snapper</p> <p>Cover</p>
3	Press on the three quick connectors on the cover of the RO/pretreatment cartridge and remove the used cartridge from the system.	 <p>Quick connectors</p> <p>RO/pretreatment cartridge</p>
4	Locate the new RO/pretreatment cartridge and insert the cartridge into the system.	

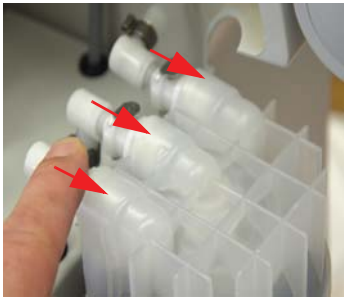
Step	Action	Figure
5	<p>Insert the quick connectors into the connecting points on the new RO/pretreatment cartridge. When you hear an audible click you can be sure that the quick-action fasteners have been inserted correctly.</p> <p>NOTICE</p> <p>The quick connectors are attached to the system in such a manner so as to prevent any confusion switching.</p>	 <p>RO/pretreatment cartridge</p>
6	<p>Replace the cover over the RO/pretreatment cartridge and switch the system on (connect main power supply).</p>	

Cleaning

NOTICE

- The Smart2Pure systems can only be disinfected as a 'stand-alone' process.
- If the system was longer time not in operation a cleaning must be performed.
- Cleaning should be performed at regular intervals, such as when the ultrapure cartridge is exhausted and must be changed, or when there is bacteria present the pure water.
- Depending on the version of your Smart2Pure system (with internal 5L tank Smart2Pure 3/6 or Smart2Pure 12 with external tank), a complete cleaning will take between 1 to 5 hours.

Required for cleaning is a cleaning adapter (item no: 50133431).

Use the following disinfecting agents for cleaning:

Cleaning Solution, 1 syringe, item no.: CMX 25.

NOTICE

- To ensure effective cleaning of your system the internal 5L or external tank must be filled completely with water.
- There is no need to worry should you notice a chlorine smell during the entire cleaning process, as there is no risk of the limit for chlorine gas in closed rooms being exceeded.



Always wear protective gloves when handling the cleaning solution.





Always wear safety goggles when handling the cleaning solution.

CAUTION

If your skin should come into contact with a chlorine product, rinse it immediately with ample, fresh water. If your eyes come into contact with the disinfecting agent, rinse them immediately with ample, fresh water and contact a physician at once.

WARNING

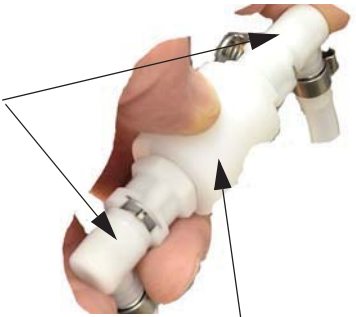
Observe the information provided on the data sheet supplied with the CLEANING Solution to avoid any possible health hazards.

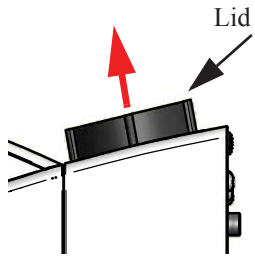
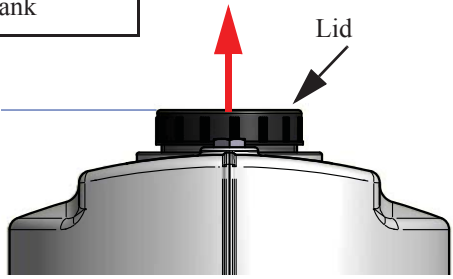
Step	Action	Figure
1	a. Switch the system off (unplug main power supply) and close the feedwater tap. b. Remove the ultrapure cartridge. (see "Replacing the ultrapure cartridge" on page 65) and replace the RO/pretreatment cartridge. (see "Replacing the RO/pretreatment" on page 66)	
2	a. Click in the adapter for cleaning into the both quick connectors for the ultrapure cartridge. When you hear an audible click you can be sure that the quick-connectors have been inserted correctly.	a.)  <p>Quick connectors</p> <p>Adapter for cleaning</p>
3	<div data-bbox="277 1066 542 1184" style="display: flex; justify-content: space-around;">   </div> <p>Always wear protective gloves and goggles when handling cleaning solution.</p> a. Switch the system on(connect main power supply), open the feedwater tap and wait until the internal 5L tank or external tank is filled with water and pour the contents of one syringe of cleaning solution into the internal 5 L tank or external tank. Therefore open the lid of the tanks. b. Close the feedwater tap.	<div data-bbox="971 1058 1130 1136" style="border: 1px solid black; padding: 2px;">Lid internal tank</div>  <div data-bbox="971 1430 1130 1507" style="border: 1px solid black; padding: 2px;">Lid external tank</div> 
4	Let the Smart2Pure system run for 1 hour.	

NOTICE

There is no need to worry should you notice a chlorine smell during the entire cleaning process, as there is no risk of the limit for chlorine gas in closed rooms being exceeded.

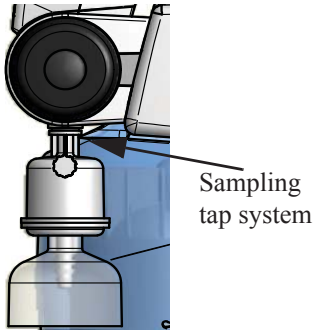
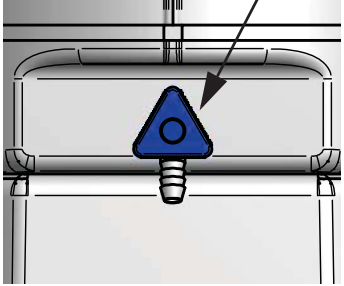
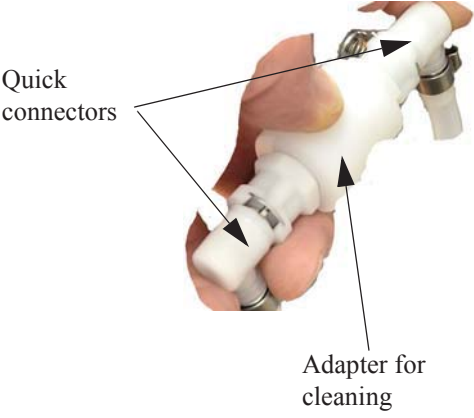
Step	Action	Figure
5	<p>a. Once the cleaning is completed drain the disinfecting solution from the internal 5L tank through the sampling tap. Close the sampling tap and open the feedwater tap and run 2 tank fillings of feedwater through the sampling tap.</p> <p>b. If you are using a Smart2Pure 12 system with external tank drain the content of water into the drain by open the dispensing valve on the tank. Open the feedwater tap and wait until the tank is filled for run one tank filling through the sampling tap.</p> <p>c. Switch the system off (unplug main power supply) disconnect the adapter for cleaning and put in the new ultrapure cartridge. (see "Replacing the ultrapure cartridge" on page 65)</p> <p>d. Switch the system on (connect the main power supply) and drain the first 10 L through the dispensing valve.</p>	<p>a.)</p>  <p>Sampling tap system</p> <hr/> <p>b.)</p>  <p>Dispensing valve external tank</p> <hr/> <p>c.)</p>  <p>Quick connectors</p> <p>Adapter for cleaning</p>

Changing the ultrafilter

NOTICE

You will need the following tools for replacing the ultra-filter:
Open-end wrench, size 17, Phillips screwdriver and Teflon tape.

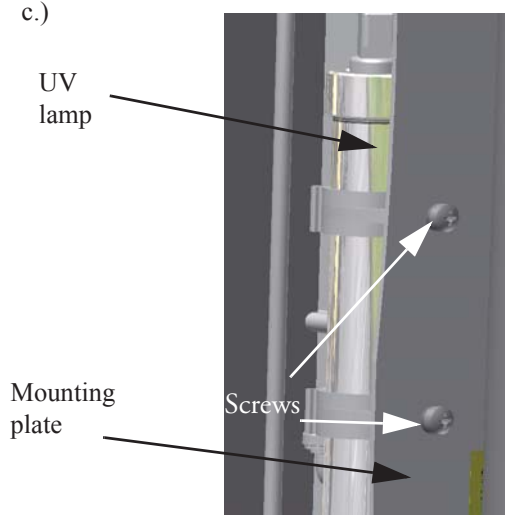
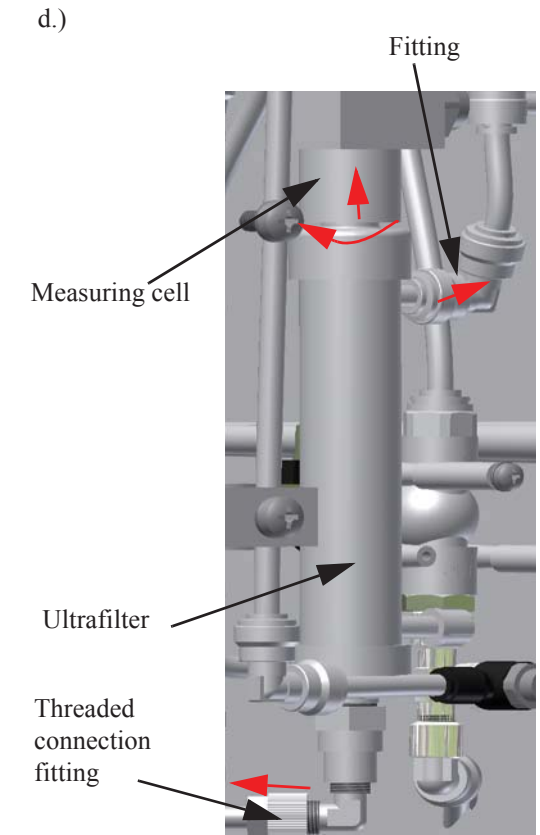
Step	Action	Figure
1	Switch the system off (unplug main power supply).	
2	<ol style="list-style-type: none"> Remove the cover from the system. Take out the ultrapure cartridge and RO/pretreatment cartridge (see "Replacing the ultrapure cartridge" on page 65 and "Replacing the RO/pretreatment" on page 66). Use the Phillips screwdriver to unscrew the screws from the bracket for the UV lamp and pull the UV assembly out toward the front. Unscrew the threaded connection screws by hand on the d1/4" fittings of the ultra-filter and pull the tubes out. Disconnect the fitting on the upper side from the ultra-filter. Twist the ultrafilter to turn out the measuring cell from the upper side from the ultrafilter. 	<p>c.)</p>  <p>UV lamp</p> <p>Mounting plate</p> <p>Screws</p> <p>d.)</p>  <p>Fitting</p> <p>Measuring cell</p> <p>Ultrafilter</p> <p>Threaded connection fitting</p>

NOTICE

Ensure that the white O-rings on the 1/4" inch tubes are not lost in the process. You will need these again for re-attaching the tube.

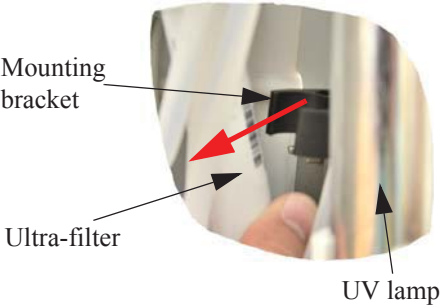
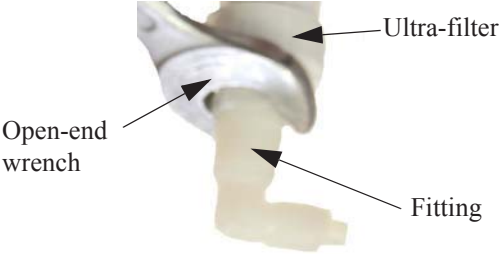
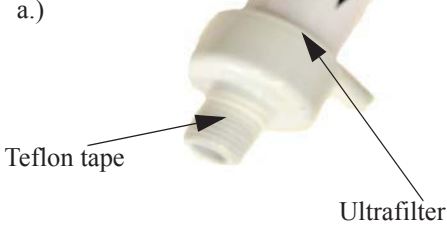
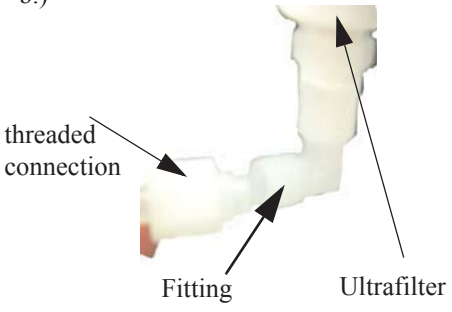
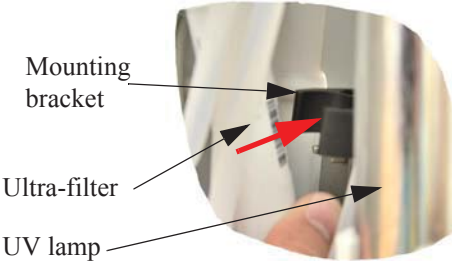
Step	Action	Figure
3	<p>a. Pull the ultra-filter out of the mounting bracket.</p> <p>b. Mark the position of the bottom fitting before you remove them. Use the open-end wrench size 17mm/ 0.67 inch to unscrew the bottom fitting on the ultra-filter.</p>	<p>a.) </p> <p>b.) </p>
4	<p>NOTICE</p> <p>When you install a new ultra-filter ensure that the arrow on the filter corresponds to the direction of flow through the filter (it must point upward).</p> <p>a. Take the new ultra-filter and wrap the bottom threads in Teflon strip (roughly 3 times around).</p> <p>b. Take the fitting that you unscrewed in step 3b and screw the fitting into the same position that it was on the old ultrafilter. Use the 17mm/0.67 inch open-end wrench for this.</p> <p>c. Screw on the measuring cell and insert the tubes into the top and bottom connection for the ultra-filter and screw the fittings securely into place.</p> <p>d. Insert the ultra-filter back into the mounting bracket and screw back the UV assembly into place (see Step 2c).</p> <p>a. Replace the cover on the system, open the feedwater tap and switch the system on (connect main power supply). Dispense the first 5 L of water.</p>	<p>a.) </p> <p>b.) </p> <p>c.) </p>

UV-reactor assembly

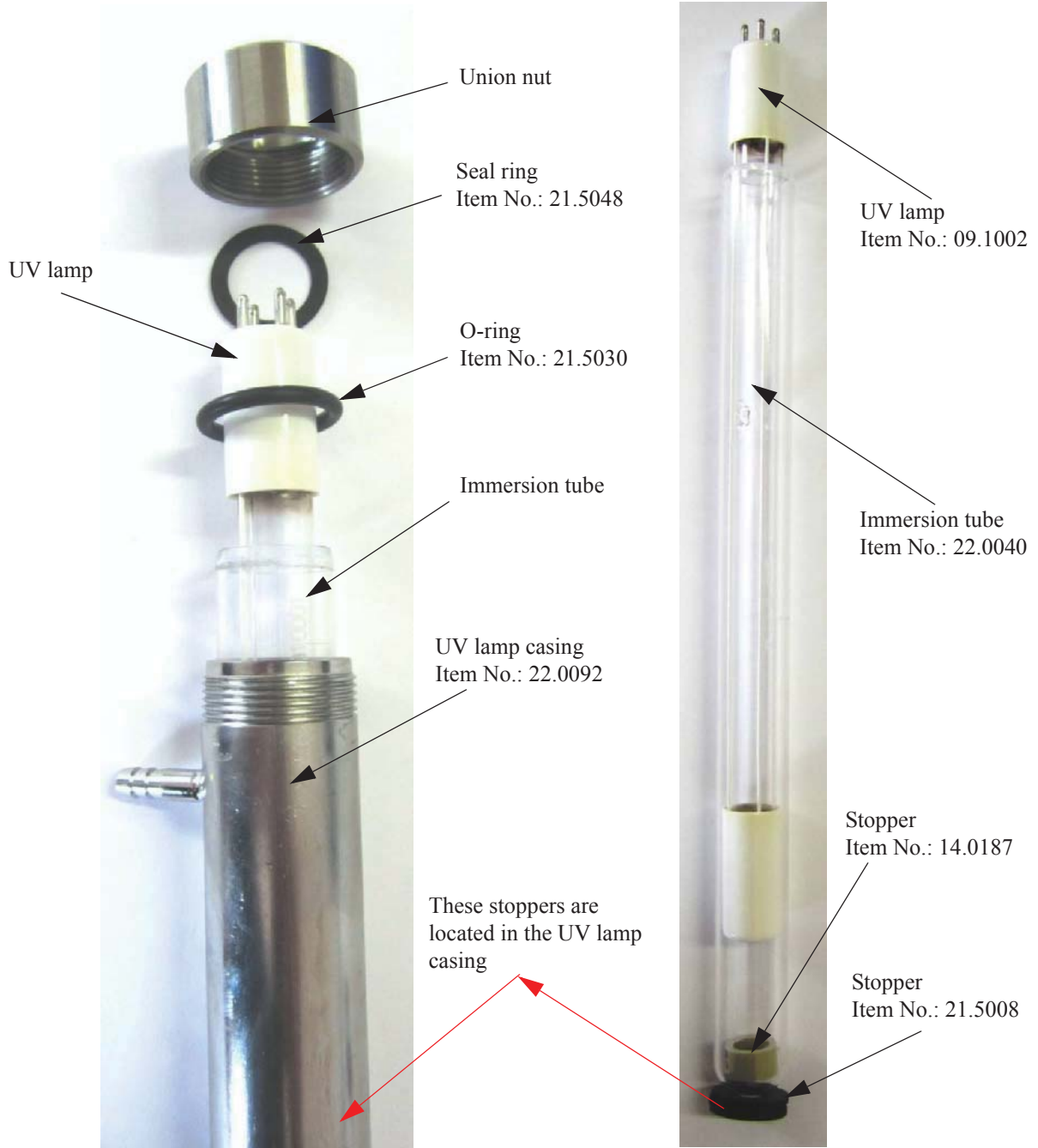

Replacing the UV lamp

WARNING



NOTICE

Never look directly into a UV lamp when it is on. It could damage your sight.

Always wear safety gloves when changing the UV-lamp, in order to prevent that your skin comes in contact with the UV-lamp glass.

Wear directly a breathing protector when you are seeing that the glass of the UV-lamp is broken and ventilate the room well.

The Hg content in the UV-lamp is so low so that no damage to the environment can arise.

Contact your local Service organization to proceed as the proper disposal of the used UV-lamp

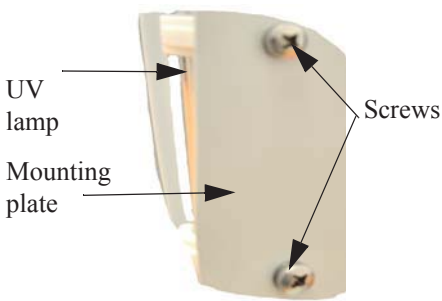
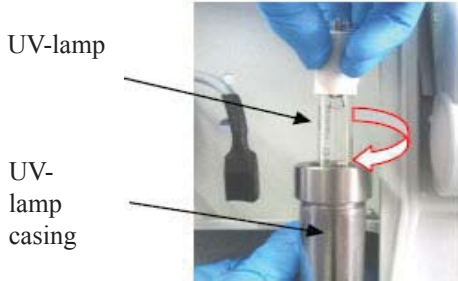
Step	Action	Figure
1	Switch the Smart2Pure system off. (Unplug from main power supply)	
2	Remove the cover for the ultrapure cartridge.	
3	a. Take the ultrapure cartridge out of the system (see " Replacing the ultrapure cartridge " on page 65) and the installed RO/pretreatment cartridge (see " Replacing the RO/pretreatment " on page 66). b. Use the Phillips screwdriver to unscrew the two screws from the bracket for the UV assembly.	b.) 
4	<div style="background-color: #0056b3; color: white; padding: 5px; text-align: center; font-weight: bold; font-size: 1.2em;">NOTICE</div> To more easily remove the UV lamp in the next step, pull the UV lamp out by about 1cm while still plugged in.	
5	a. Carefully unplug the plug for the UV lamp. b. Now, carefully pull the UV lamp up while turning it slightly in a clockwise direction at the same time.	

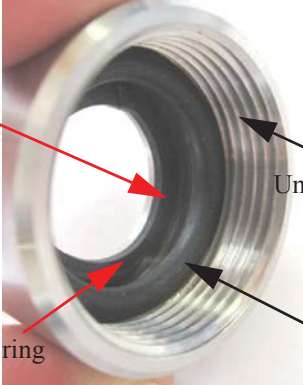
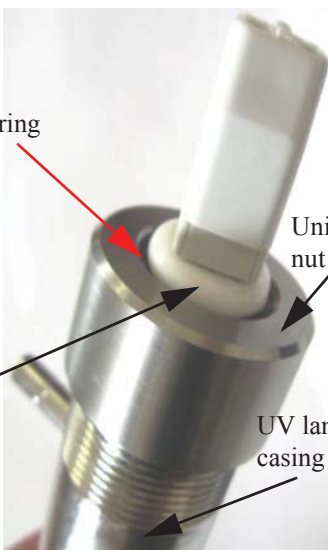
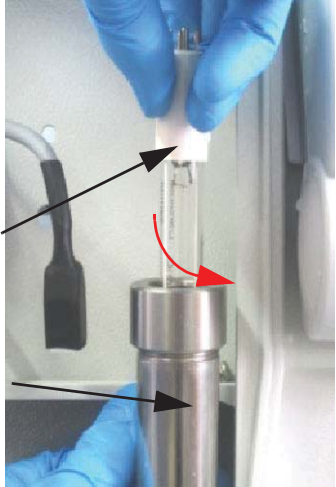
Step	Action	Figure
6	<p data-bbox="256 247 553 327">CAUTION</p> <p data-bbox="256 394 974 562">When you are removing the UV lamp you must ensure that the glass of the UV lamp is not soiled or that you do not touch it with your fingers. This could impair proper functioning of the lamp. We therefore recommend that you wear clean, disposable gloves when performing this work.</p> <p data-bbox="256 575 553 655">CAUTION</p> <p data-bbox="256 655 974 903">When installing a new UV lamp ensure that the flat seal ring and the O-ring are on the correct position. The flat seal ring must fit exactly in the groove provided for it on the top of the union nut (figure 1 and 2). The O-ring fits in the bottom groove in the union nut (figure 1). If these items do not fit exactly in the grooves and you restart the system, the UV assembly will not be leak-tight at these locations.</p> <ol data-bbox="305 955 974 1218" style="list-style-type: none"> Now, carefully rotate a new UV lamp into place by turning it in a counter-clockwise direction into the UV assembly (figure 3). You can then re-attach the plug to the UV lamp and retighten the UV assembly on the mounting plate using the two retaining brackets and the two screws that you removed previously. 	<p data-bbox="998 210 1023 241">a)</p> <p data-bbox="1031 262 1055 294">1.</p>  <p data-bbox="998 346 1079 378">Groove</p> <p data-bbox="1031 598 1128 630">Seal ring</p> <p data-bbox="1356 430 1453 462">Union nut</p> <p data-bbox="1404 609 1469 640">O-ring</p> <hr/> <p data-bbox="1015 724 1039 756">2.</p>  <p data-bbox="1015 892 1112 924">Seal ring</p> <p data-bbox="998 1176 1063 1228">UV lamp</p> <p data-bbox="1372 997 1437 1029">Union nut</p> <p data-bbox="1339 1186 1437 1249">UV lamp casing</p>
		<p data-bbox="998 1365 1023 1396">a)</p>  <p data-bbox="998 1564 1047 1627">UV lamp</p> <p data-bbox="998 1690 1096 1753">UV lamp casing</p>

Step	Action	Figure
7	Insert the ultrapure cartridge back into the system (see "Replacing the ultrapure cartridge" on page 65) and the RO/pretreatment cartridge too (see "Replacing the RO/pretreatment" on page 66).	
8	Switch the system on (connect main power supply).	

Replacing the 0.2 μm final filter

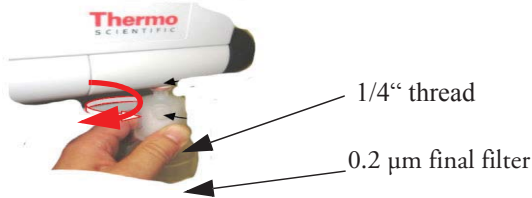
Step	Action	Figure
1	Rotate the exhausted or clogged 0.2 μm final filter in a clockwise position to remove it.	
2	Unpack the new 0.2 μm final filter and screw it into the bottom 1/4" thread on the sampling tap. Vent final filter and rinse 500 ml through it.	

Autoclaving the 0.2 μm final filter

NOTICE

The lifetime of the 0.2 μm final filter can be prolonged by sterilizing it. Proceed as follows to autoclave the sterile filter.

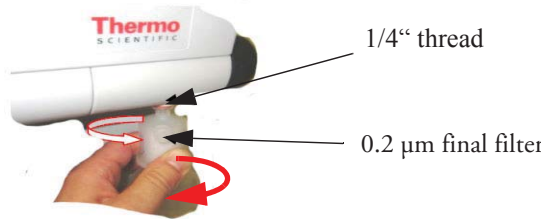
Step	Action	Figure
1	Rotate the used 0.2 μm final filter in a clockwise direction to remove it.	
2	Use an autoclave to sterilize the 0.2 μm final filter in a steam autoclave at 121°C for 30 minutes. You can repeat the sterilization process for the sterile filter up to 5 times. When sterilization is completed, screw the 0.2 μm final filter back into the 1/4" thread on the sampling tap (see "Replacing the 0.2 μm final filter" on page 76).	<h3>NOTICE</h3> <p>If you wish to remove purified water and the flow rate is too low, this is an indication that the sterile filter is clogged. In this case, read the description in section "Trouble shooting" on page 79, or replace the 0.2 μm final filter with a new one.</p>

Waste disposal

NOTICE

Before returning your Thermo Scientific Barnstead Ultrapure Water Systems for waste disposal, contact your local service organization or waste disposal company for proper disposal of the system and its components. Only specially trained personal can take the system out of operation and dispose it properly.

If you have a used or broken UV-lamp, contact your local Thermo Scientific service organization or waste disposal company.

When the packaging is no longer needed it can be disposed of as household waste.

Systems are in conformity with EEC Guideline 2011/65/EC.

The system is not to be thrown away as household waste but must be properly disposed of. It can be returned to the manufacturer for safe disposal according to EEC Guideline 2011/65/EC. We therefore request our customers in Germany and other member States in the European Economic Area to contact our local service centre or our headquarters.

wEEE.recycle@thermofisher.com

WEEE-Reg.-no.: DE 12471402

In countries outside of the European Economic Area, please contact your local authorities or waste disposal company.

Trouble shooting

NOTICE

Contact the service department if you cannot rectify this error.

Error	Cause	Remedy
The system does not start	<ul style="list-style-type: none"> No supply of power Power pack or system control defect 	<ul style="list-style-type: none"> Provide power Replace the power pack or system control
Dispensing not possible/ storage tank is empty	<ul style="list-style-type: none"> Feedwater supply is closed Feedwater and concentrate water connections are mixed up Feedwater pressure < 1 bar Sterile filter blocked RO/pretreatment cartridge blocked. 	<ul style="list-style-type: none"> Open the feedwater supply line Replace connections Increase feedwater pressure Replace the sterile filter (see “Replacing the 0.2 µm final filter” on page 76) Install new RO/pretreatment cartridge (see “Replacing the RO/pretreatment” on page 66 or check RO/pretreatment cartridge connections.
Resistance < 18.2 MΩ·cm/ 0.055 µS/cm	<ul style="list-style-type: none"> Ultrapure cartridge is exhausted Air in the ultrafilter because of empty tank 	<ul style="list-style-type: none"> Check feedwater quality Insert new ultrapure cartridge Wait until the tank is again filled and a rinse is triggered
Control panel non responsive	<ul style="list-style-type: none"> Microprocessor locked up PCB error 	<ul style="list-style-type: none"> Unplug the mains plug for 5 seconds. Contact the Thermo Fisher Scientific service department

Error	Cause	Remedy
Water leak	<ul style="list-style-type: none"> Leaky tubing connection Feedwater pressure > 6 bar Component defect (e.g. UV quartz tube) 	<ul style="list-style-type: none"> Check and seal the tubing connection Install a pressure reducer Contact the Thermo Fisher Scientific service department
Dispensed water flow rate is too low	<ul style="list-style-type: none"> Ultrafilter is blocked 0.2 micron final filter is blocked Air in 0.2 micron final filter 	<ul style="list-style-type: none"> Replace ultrafilter (see “Changing the ultrafilter” on page 71) Replace the 0.2 micron final filter Vent the 0.2 micron final filter
Error message: Red LED in second line is light up “Limit value Cond.”	<ul style="list-style-type: none"> exhausted ultrapure cartridge Limiting value set too low 	<ul style="list-style-type: none"> Replace with new ultrapure cartridge Check and reset the limiting value
Error message: Red LED in second line is light up “Limit value Temp.”	<ul style="list-style-type: none"> Temperature in system is too high Limiting value is set too low Feedwater temperature is too high 	<ul style="list-style-type: none"> Reduce temperature by letting water flow out Check and reset the limiting value Reduce the feedwater temperature
Error message: Red LED in second line is light up “Status Sens.”	<ul style="list-style-type: none"> Interruption in cable to conductivity measuring cell Measuring cell defect 	<ul style="list-style-type: none"> Check the cable and plug connection Contact Thermo Scientific for replacing
Error message: Red LED in second line is light up “Status Sens.” The display shows “- -” with audible alarm.	<ul style="list-style-type: none"> Interruption in cable to conductivity measuring cell Temperature sensor in measuring cell defect 	<ul style="list-style-type: none"> Check the cable and plug connector Contact Thermo Scientific for replacing

Replacement parts

NOTICE

Please note that the use of spare parts, accessories or wear parts from other manufacturers will nullify the warranty for this unit.

Contents

- “Replacement parts Smart 2Pure 3/6” on page 82
- “Replacement parts Smart2Pure 12” on page 84
- “Replacement parts pure water tank for Smart2Pure 12” on page 86

Replacement parts Smart 2Pure 3/6

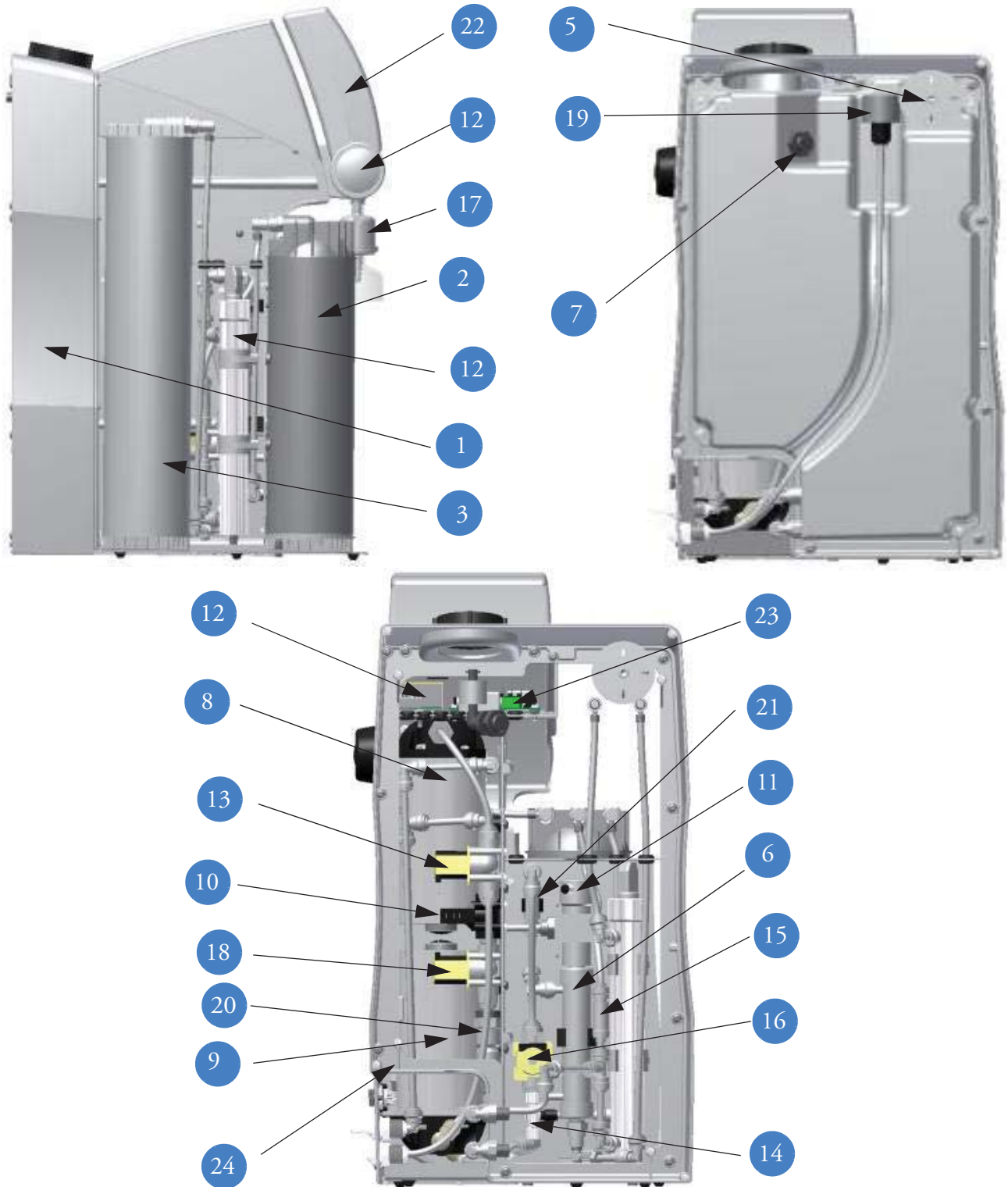

Pos.	Designation	Article number
1	Ultra pure water tank	17.0136
2	RO/pretreatment cartridge with activated carbon and RO for Smart2Pure 3	09.2003 09.2006
	RO/pretreatment cartridge with activated carbon and RO for Smart2Pure 6	
3	Ultrapure cartridge	09.1020
4	Final 0.2 micron filter	09.1003
5	Sterile vent filter	22.0091
6	Ultrafilter	50133981
7	Float switch	50133991
8	Pressure booster pump	50149262
9	Recirculation pump	50149264
10	Pressure switch	50133982
11	Ultra pure water measuring cell Temperature sensor	50133994
12	Replacement UV-lamp UV booster	09.1002 50143195
13	Feedwater solenoid valve	15.0062
14	Pressure hold valve (for concentrate)	15.0113
15	Check valve	15.0114
16	Rinsing solenoid valve	15.0062
17	Dispensing valve	50133988
18	Recirculation solenoid valve	15.0062
19	Sterile tank overflow	50148548
20	Check valve	50150598
21	Check valve	15.0114
22	Control Board with display	16.0351
23	Interface	16.0337
24	Fuse holder for glass tube fuse Glass tube fuse 5x20mm, 3,15 A, slow fuse	50143154 50150714
25	Tabletop power pack (not shown)	50149597

Replacement parts Smart2Pure 12

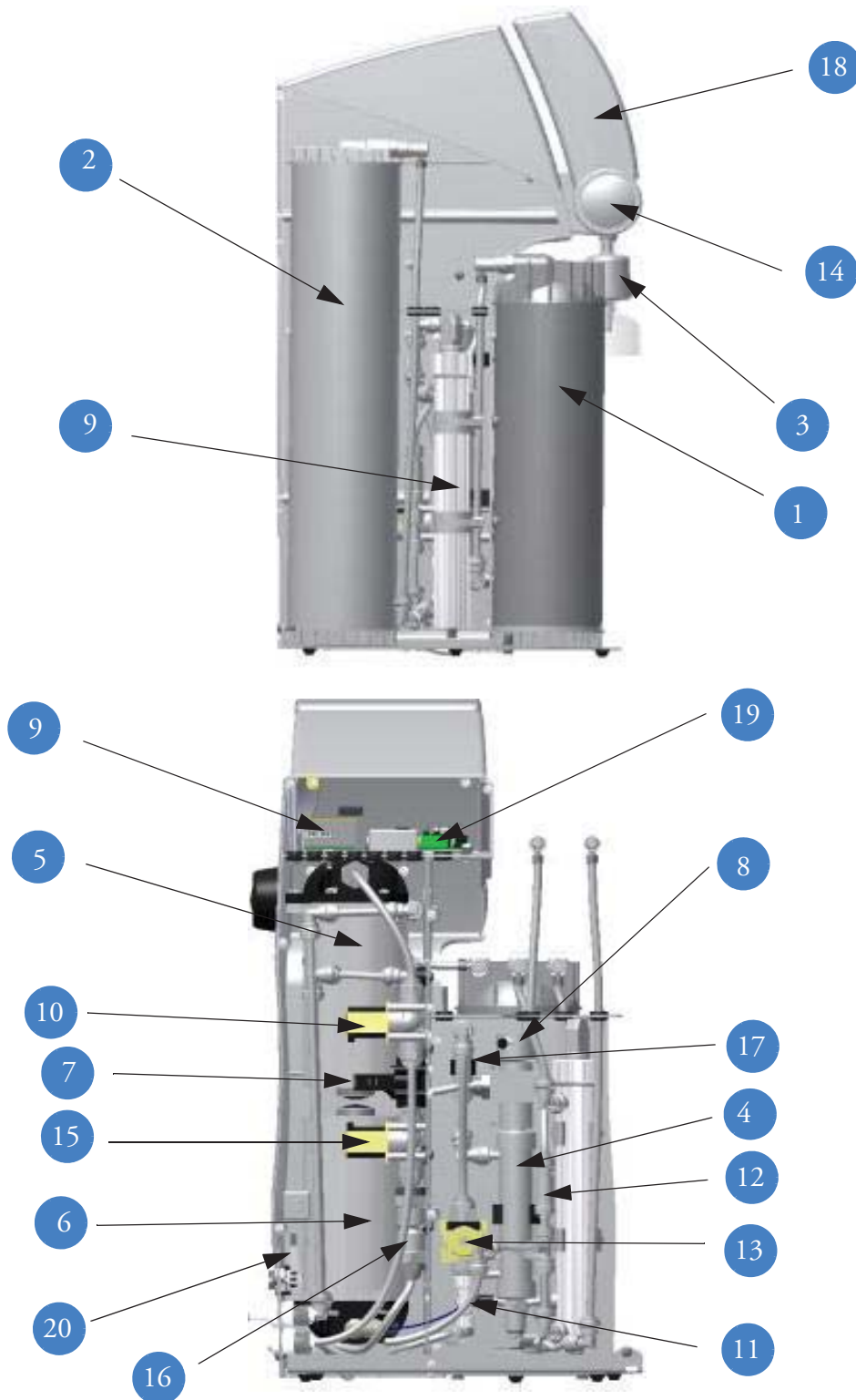

Pos.	Designation	Article number
1	RO/pretreatment cartridge with activated carbon and RO	09.2012
2	Ultrapure cartridge	09.1020
3	Final 0.2 micron filter	09.1003
4	Ultrafilter	50133981
5	Pressure booster pump	50149262
6	Recirculation pump	50149264
7	Pressure switch	50133982
8	Ultra pure water measuring cell Temperature sensor	50133994
9	Replacement UV-lamp UV booster	09.1002 50143195
10	Feedwater solenoid valve	15.0062
11	Pressure hold valve (for concentrate)	15.0113
12	Check valve	15.0114
13	Rinsing solenoid valve	15.0062
14	Dispensing valve	50133988
15	Recirculation solenoid valve	15.0062
16	Check valve	50150598
17	Check valve	15.0114
18	Control Board with display	16.0351
19	Interface	16.0337
20	Fuse holder for glass tube fuse Glass tube fuse 5x20mm, 3,15 A, slow fuse	50143154 50150714
21	Tabletop power pack (not shown)	50149597

Replacement parts pure water tank for Smart2Pure 12

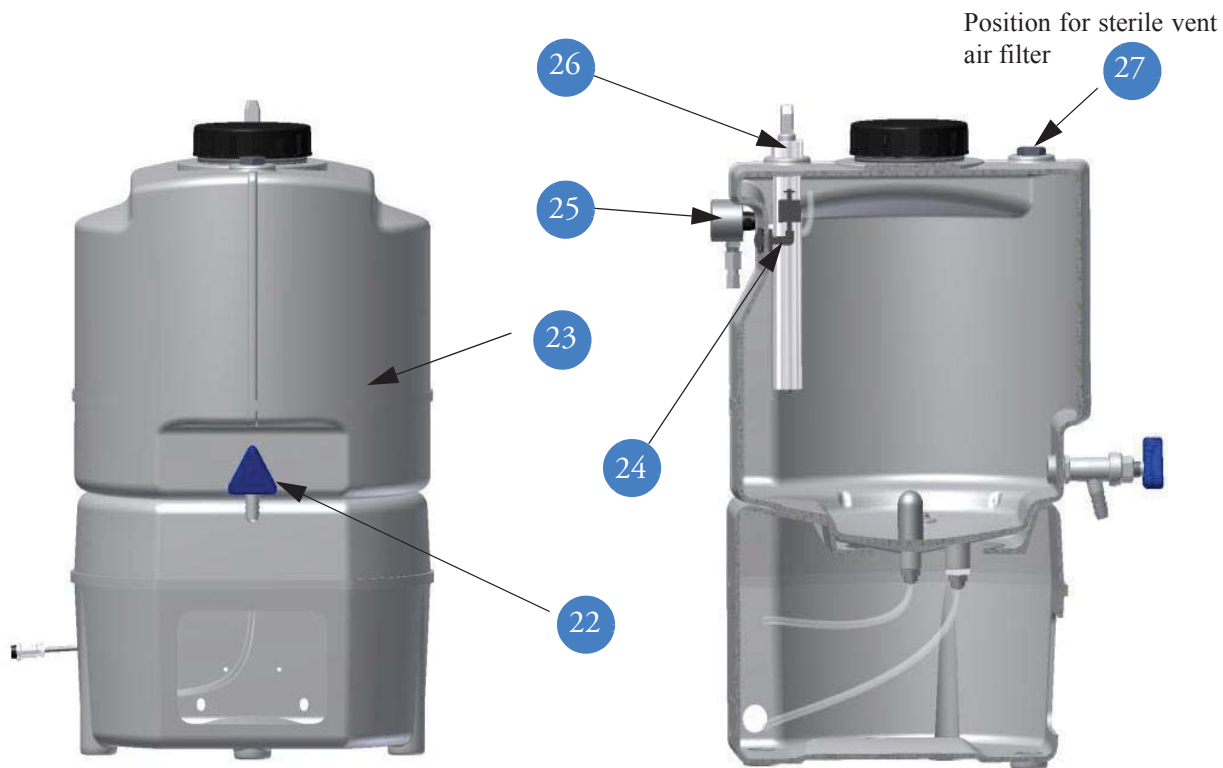

Pos.	Designation	Article number
22	Dispensing valve	14.0250
23	Pure water tank 30 liters Pure water tank 60 liters	18.0114 18.0115
24	Float switch	50133991
25	Sterile tank overflow (option)	50148041
26	Replacement UV-lamp (option)	09.5002
27	Sterile vent air filter (option)	06.5003

Consumables

Designation	Item No.
Ultrapure cartridge	09.1020
UV lamp	09.1002
Ultrafiltration module	50133981
Sterile filter 0.2 µm	09.1003
RO/pretreatment cartridge for:	
Smart2Pure 3	09.2003
Smart2Pure 6	09.2006
Smart2Pure 12	09.2012
Sterile vent air filter	22.0091
CO ² vent filter	06.5002

Accessories

Designation	Item No.
External pretreatment 5µm 10" with hardness stabilization and carbon (Includes filter housings, tubing, 06.5452 - hardness stabilizer cartridge and 06.5201 5 µm prefilter and activated carbon cartridge)	09.4000
Printer	09.2207
Accessory hand dispenser	50138221
Cleaning Solution, 1 syringe	CMX25
Wall bracket	09.2212
Replacement UV-lamp for pure water tanks	09.5002
Sterile tank overflow	06.5001

Terminal assignment

18 Terminal assignment

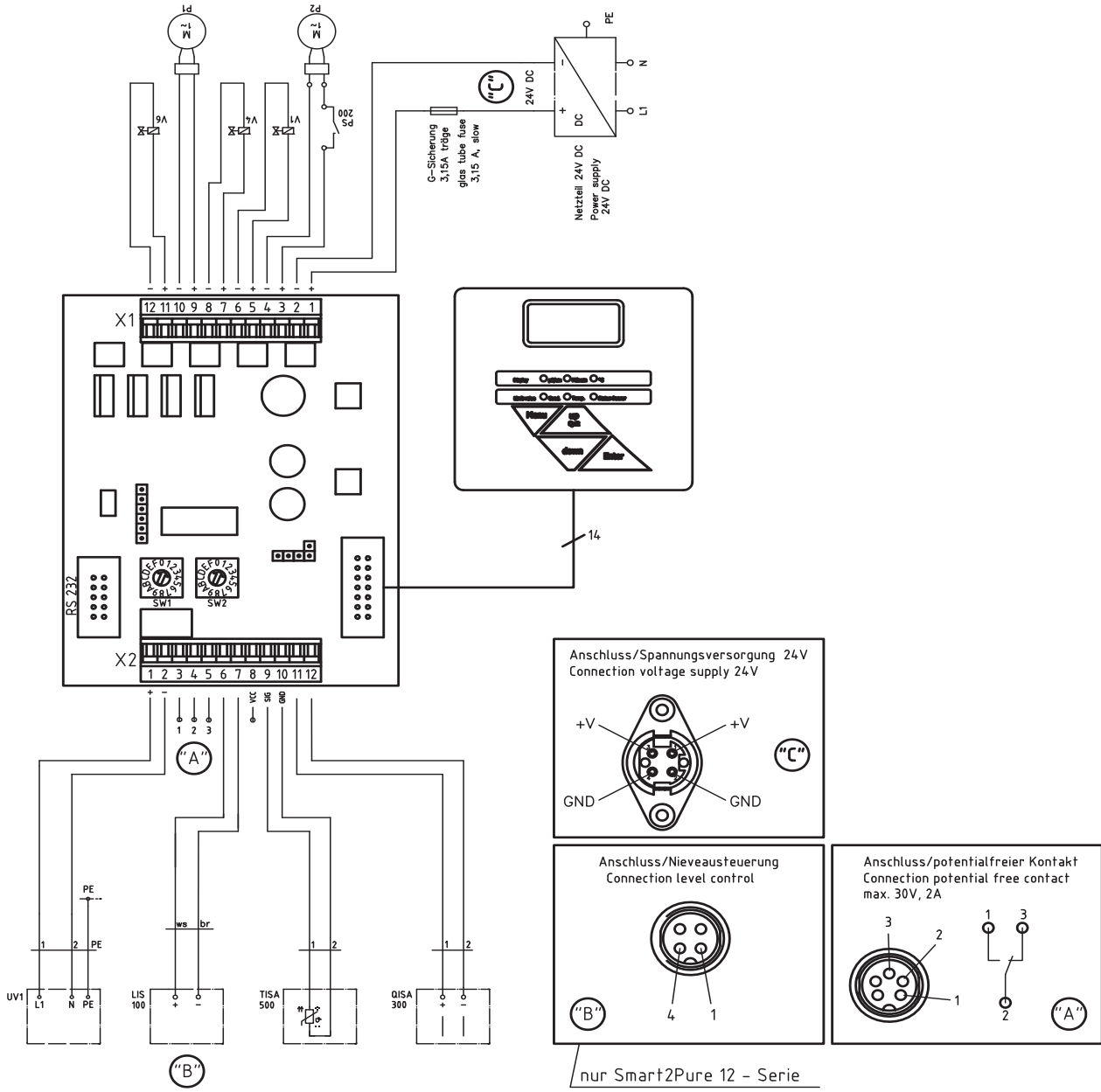

nur Smart2Pure 12 - Serie
only Smart2Pure 12 - series

X 1	1, 2	Spannungsversorgung 24V
	3,4	Rezirkulationspumpe (P2), Druckschalter (PS200)
	5,6	Rohwasser-Magnetventil (V1)
	7,8	Spülmagnetventil (V4)
	9,10	Druckerhöhungspumpe (P1)
	11,12	Rezirkulations-Magnetventil (V6)
X 2	1,2	UV-Fotooxidation (UV1)
	3	Pot. freier Kontakt
	4	Pot. freier Kontakt
	5	Pot. freier Kontakt
	6,7	Niveau Kontakt (LIS100)
	8 (VCC)	
	9 (SIG)	Temperatursensor (TISA500)
10 (GND)	Temperatursensor (TISA500)	
11,12	Leitfähigkeitsmesszelle Reinstwasser (QISA300)	

X 1	1, 2	Power supply 24V
	3,4	Recirculation pump (P2), Pressure switch (PS200)
	5,6	Rawwater solenoid valve (V1)
	7,8	Rinsing solenoid valve (V4)
	9,10	Booster pump (P1)
	11,12	Recirculation solenoid valve (V6)
X 2	1,2	UV-fotooxidation (UV1)
	3	Pot. free contact
	4	Pot. free contact
	5	Pot. free contact
	6,7	Level contact (LIS100)
	8 (VCC)	
	9 (SIG)	Temperature sensor (TISA500)
10 (GND)	Temperature sensor (TISA500)	
11,12	Conductivity measuring cell (QISA300)	

Maintenance record

Customer address: _____ **Location:** _____

_____ **System type:** _____

_____ **Serial no.:** _____

_____ **Year made:** _____

Date	Ultrapure water resistance [MΩxcm]	Temperature [°C]	Last change of RO/pretreatment cartridge	Last change of external pretreatment cartridge	Last change of UV lamp

Ultra pure water volume flow [l/h]	Last change of ultrapure cartridge	Last cleaning	Last check of concentrate flow	Signature

The following points must be observed in order to ensure the quality of the system.

1x / Weekly, enter measured values.

Contact information Thermo Fisher Scientific

Contact address for service:

Overview of Thermo Scientific international sales organization

Postal address in USA:

Thermo Scientific
275 Aiken Road
Asheville, NC 28804
USA

Inquiries from USA/Canada

Sales: +1 866 984 3766

Service: +1 800 438 4851

Enquiries from Latin America

Sales: +1 866 984 3766

Service: +1 866 984 3766

Enquiries from Asia:

China

Sales: +86 10 8419 3588

Service: toll-free 1-8008105118

Support Mobile 4006505118 or +86 10 8419 3588

India

Sales: +91 22 6716 2200

Service: toll-free 1-800 22 8374 or +91 22 6716 2200

Japan

Sales: +81 45 453 9220

Service: +81 45 453 9224

Inquiries from other countries Asia/ Australia/ New Zealand

Sales: +852 2885 4613

Service: +65 6872 9720

Inquiries from countries not listed here/ other EMEA countries

Sales: +49 6184 90 6940 or +33 2 2803 2000

Service: +49 6184 90 6940

Enquiries from Europe:

Austria

Sales: +43 1 801 40 0

Service : +43 1 801 40 0

Belgium

Sales: +32 53 73 4241

Service: +32 53 73 4241

Finland/Nordic/Baltic Countries

Sales: +358 9 329 100

Service: +358 9 329 100

France

Sales: +33 2 2803 2180

Service : +33 825 800 119

Germany

Postal Address Germany:

Thermo Electron LED GmbH

Robert-Bosch-Straße 1

D - 63505 Langenselbold

Phone

Sales: toll-free 0800 1 536 376

or +49 6184 90 6940

Service: toll-free 0800 1 112110

or +49 6184 90 6940

E-mail: info.labequipment.de@thermofisher.com

Italy

Sales: +39 02 95059 341

Service: +39 02 95059 250

Netherlands

Sales: +31 76 579 5555

Service: +31 76 579 5639

Russia/CIS

Sales: +7 812 703 4215

Service: +7 812 703 4215

Spain / Portugal

Sales: +34 93 223 0918

Service: +34 93 223 0918

Switzerland

Sales: +41 44 454 1212

Service: +41 44 454 1212

UK/Ireland

Sales: +44 870 609 9203

Service: +44 870 609 9203

© 2015 Thermo Fisher Scientific Inc. All rights reserved. All trademarks are the property of Thermo Fisher Scientific Inc. and its subsidiaries. Specifications, terms and pricing are subject to change. Not all products are available in all countries. Please consult your local sales representative for details.



A

- Accessibility to Smart2Pure systems and pure water tank 21
- Accessories 87
- Airborne sound emission 22
- Ambient conditions 22
- Attaching the wall holder for 30 or 60L pure water tank 36
- Attaching wall holder for 30L pure water tank 37
- Attaching wall holder for 60L pure water tank 40
- Autoclaving the sterile filter 76
- Available Smart2Pure 12 systems 13
- Available Smart2Pure 3/6 systems 12
- Available storage tanks for Smart2Pure 12 systems 13

C

- Communication 61
- Complaints 2
- Connecting a external tank to the Smart2Pure 12 system 34
- Connections of the pure water tank Smart2Pure 12 30
- Connections of the Smart2Pure 12 system 28
- Connections of the Smart2Pure 3/6 system 26
- Consumables 87
- Contact information Thermo Fisher Scientific 93

D

- Dimensions and weight 30L and 60L pure water tank 20
- Dimensions and weight of Smart2Pure12 19
- Dimensions and weight Smart2Pure 3/6 18
- Disinfection 68
- 54 54

E

- Electrical connections 21
- Error message and acoustic error signal 61
- Examination on receipt 2
- Explanatory notes on the operating instructions ii

- Extend of delivery 9
- Extend of Delivery Smart2Pure 12 11
- Extend of delivery Smart2Pure 3/6 10

F

- Feedwater requirements 17
- Flow chart 47

H

- How the Smart2Pure system functions 49

I

- Illustration of drain 35
- Index 97
- Installation 25
- Intended Use 15
- Intended Use of the device 15

L

- Legal Information ii

M

- Maintenance 63
- Maintenance Intervals 64
- Maintenance record 91
- Materials of parts which contact water 21
- Menu 58
- Mono/dual measurement mode 58
- Mounting the power pack (voltage supply) 43

O

- Operating Elements 55

P

- Packaging for return shipment 2

Index: R

Permeate and concentrate performance for Smart2Pure 18
Preface i
Product water quality ASTM Type I (on dispensing valve) 17
Product water quality ASTM Type II (tank quality) 17
Putting system into operation 52

R

Replacement parts 81
Replacement parts pure water tank for Smart2Pure 12 86
Replacement parts Smart 2Pure 3/6 82
Replacement parts Smart2Pure 12 84
Replacing the pretreatment cartridge 66
Replacing the sterile filter 76
Replacing the ultrapure cartridge 65
Replacing the UV lamp 74

S

Safety Precautions 5
Setting the limiting value for conductivity 59
Setting the limiting value for temperature 60
Standards and directives iv
Start your Smart2Pure system into operation 31
System control 57

T

Technical Specifications 17
Terminal assignment 89
The Installation area 23
Transport and packaging 1
Trouble shooting 79

U

Unintended use 15
UV-reactor assembly 73

V

Venting the sterile filter 53

W

Wall mounting 42
Warranty ii
Waste disposal 77
Water connections 20



Index:



Index

Index:



Thermo Fisher Scientific,
San Jose, CA USA is ISO Certified.

thermoscientific.co

© 2016 Thermo Fisher Scientific Inc. All rights reserved. All trademarks are the property of Thermo Fisher Scientific Inc. and its subsidiaries. Specifications, terms and pricing are subject to change. Not all products are available in all countries. Please consult your local sales representative for details.

Thermo Fisher Scientific
81 Wyman Street
Waltham, MA 02451

Thermo
SCIENTIFIC
Part of Thermo Fisher Scientific